



WITTEX
INTERNATIONAL

CE Mark
ISO 9001 : 2008
ISO 13485 : 2003
FDA Approved



**TOP QUALITY DENTAL
INSTRUMENTS**

www.wittex.com

CONTENTS

01



EXTRACTING FORCEPS

Page#01-14A.B.C

02



ROOT ELEVATORS

Page#15-15A-29

03



**DIAGNOSTIC, PROBES, SCALERS,
FILLING & LABORATORY INSTRUMENTS**

Page#30-77

04



**MAXILLOFACIAL SURGERY
INSTRUMENTS**

Page#78-95

05



**ORTHODONTIC INSTRUMENTS
& PLIERS**

Page#96-107

06



DENTAL IMPLANT INSTRUMENTS

Page#108-142

07

IMPRESSION TRAY & HOLLOW WARES

Page#143-143

EXTRACTING FORCEPS

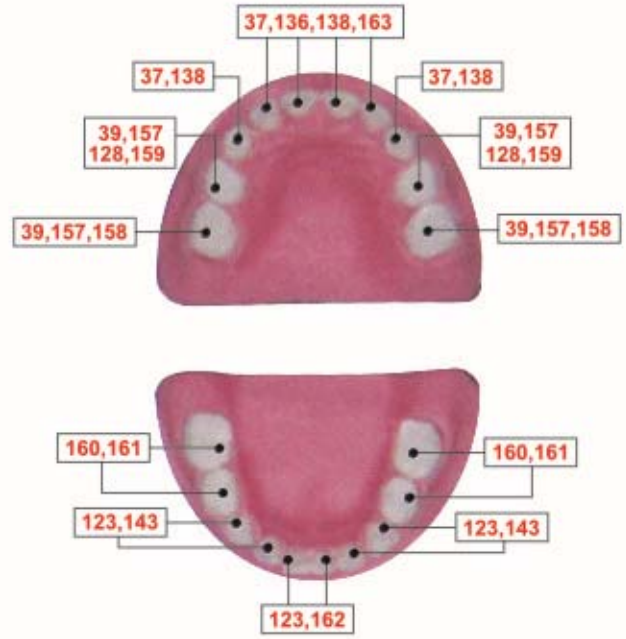
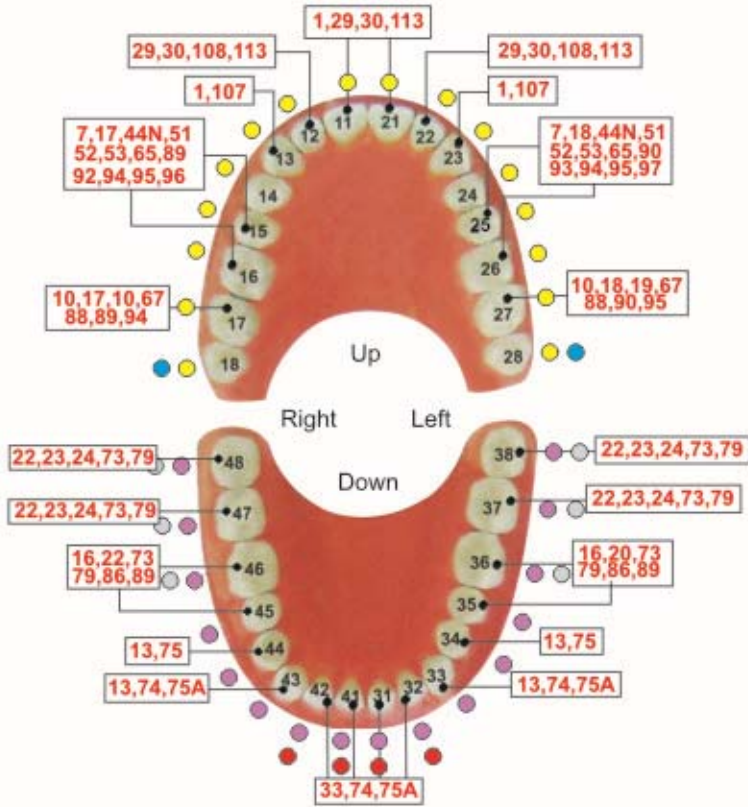

English Pattern



English Pattern
Anatomic Handle



American Pattern



Deep Grip Forceps



EXTRACTING FORCEPS (English Pattern)

- Щипцы экстракционные (английская форма)
- Deviers (Forme Anglaise)
- Zahnzangen (Englische Form)
- Щипці екстракційні (англійська форма)
- Forceps de Extraccion (Forme Inglesa)
- استخراج منقذ (الانجليزية نمط)

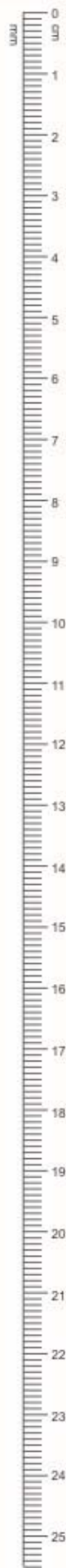

786-001
Fig. 1
Upper Centrals
and Canines



786-002
Fig. 2
Upper Laterals
and Canines



786-003
Fig. 4
Lower Incisors
and Canines



786-004
Fig. 7
Upper Premolars



786-005
Fig. 8
Lower Premolars



786-006
Fig. 13
Lower Premolars



786-007
Fig. 17
Upper Molars,
Right



786-008
Fig. 18
Upper Molars,
Left



786-009
Fig. 21
Lower Molar



786-010
Fig. 22
Lower Molar

EXTRACTING FORCEPS (English Pattern)

- Щипцы экстракционные (английская форма)
- Deviers (Forme Anglaise)
- Zahnzangen (Englische Form)
- Щипці екстракційні (англійська форма)
- Forceps de Extraccion (Forme Inglesa)
- استخراج ملقط (الانجليزية نمط)



786-011
Fig. 18A
Upper Molars

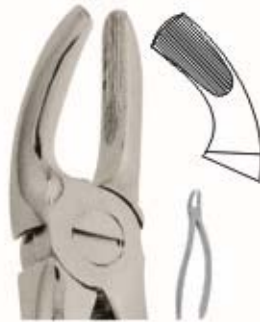

786-012
Fig. 19
Upper third Molars



786-013
Fig. 20
Lower third Molars



786-014
Fig. 24
Lower Molars
Right



786-015
Fig. 29
Upper Roots



786-016
Fig. 30
Upper Roots



786-017
Fig. 33
Lower Roots



786-018
Fig. 33A
Upper Roots



786-019
Fig. 33M
Upper Roots
with long beak



786-020
Fig. 46L
Upper Roots



786-021
Fig. 51
Upper Roots



786-022
Fig. 51A
Upper Roots



EXTRACTING FORCEPS (English Pattern)

- Шипцы экстракционные (английская форма)
- Deviers (Forme Anglaise)
- Zahnzangen (Englische Form)
- Шипці екстракційні (англійська форма)
- Forceps de Extraccion (Forme Inglesa)
- استخراج ملقط (الانجليزية نمط)

WISDOM EXTRACTING FORCEPS



786-023
Routerier
(Fig. 22 1/2 L)
Lower molars and
wisdom, Left



786-024
Routerier
(Fig. 22 1/2 R)
Lower molars and
wisdom, Right



786-025
Routerier
(Fig. 33 1/2 L)
Lower molars and
wisdom roots, Let



786-026
Routerier
(Fig. 33 1/2 R)
Lower molars and
wisdom roots, Right



786-027
Fig. 186L
Lower molars



786-028
Fig. 186R
Lower molars



786-029
Fig. 51A L



786-030
Fig. 67
Upper third molars



786-031
Fig. 67A
Upper third molars



786-032
Fig. 79
Lower third molars

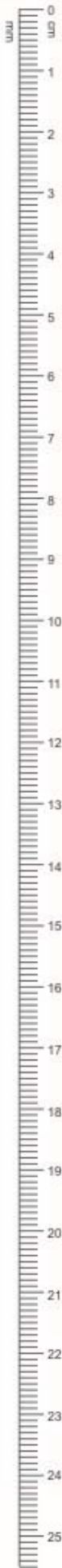

EXTRACTING FORCEPS (English Pattern)

- Щипцы экстракционные (английская форма)
- Deviers (Forme Anglaise)
- Zahnzangen (Englische Form)
- Щипці екстракційні (англійська форма)
- Forceps de Extraccion (Forme Inglesa)
- استخراج ملقط (الانجليزية نمط)



786-033
Fig. 73
Lower molars



786-034
Fig. 73 A
Lower molars



786-035
Fig. 73 S



786-036
Fig. 74
Lower roots



786-037
Fig. 74N
Lower roots



786-038
Fig. 75
Lower premolars



786-039
Fig. 86A
Lower molars



786-040
Fig. 86B
Lower molars



786-041
Fig. 86C
Lower molars



786-042
Fig. 87
Lower molars



786-043
Fig. 89
Upper molars,
Right



786-044
Fig. 90
Upper molars,
Left

EXTRACTING FORCEPS (English Pattern)

- Щипцы экстракционные (английская форма)
- Deviers (Forme Anglaise)
- Zahnzangen (Englische Form)
- Щипці екстракційні (англійська форма)
- Forceps de Extraccion (Forme Inglesa)
- استخراج مقلط (الانجليزية نمط)

A-TRAUMATIC EXTRACTION
 Improved tapered beaks for complete root contact. Cross serrations
 Deep Gripe Extracting Forceps

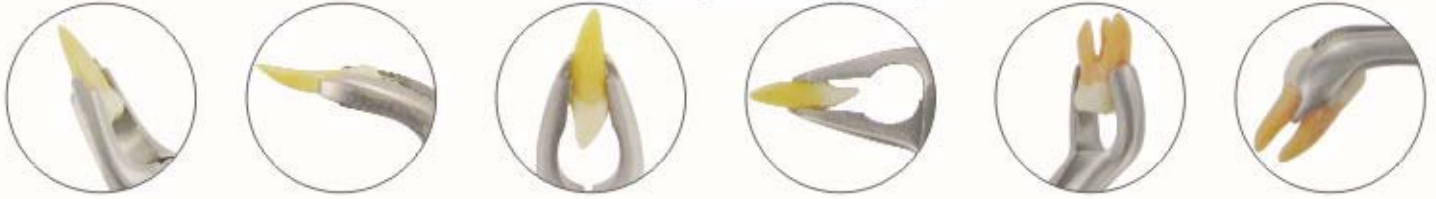

- No Fracture
- No Tissue Damage
- Extraction With Easy



786-045
 Fig. 34
 Upper incisors and
 premolars
 deep-gripping



786-046
 Fig. 34A
 Upper centrals / cains
 deep-gripping



786-047
 Fig. 35
 Upper premolars
 deep-gripping



786-048
 Fig. 35A
 Upper incisors and
 premolars
 deep-gripping



786-049
 Fig. 36
 Lower premolars
 deep-gripping



786-050
 Fig. 36A
 Lower premolars
 deep-gripping



786-051
 Fig. 336
 Lower premolars
 deep-gripping



786-052
 Fig. 7C
 Lower molar



786-053
 Fig. 9
 Apex Forceps Lower Universal
 deep root pick



786-054
 Fig. 79N
 Lower third molars
 deep-gripping



786-055
 Fig. 34
 Lower third molars
 deep gripping

EXTRACTING FORCEPS (English Pattern)

- Щипцы экстракционные (английская форма)
- Deviers (Forme Anglaise)
- Zahnzangen (Englische Form)
- Щипці екстракційні (англійська форма)
- Forceps de Extraccion (Forme Inglesa)
- استخراج ملقط (الانجليزية نمط)

DEEP GRIP FORCEPS



786-056
Fig. 146
Apex Forceps Lower Root
Deep Root Pick



786-057
Fig. 153
Apex Forceps Upper Root
Deep Root Pick

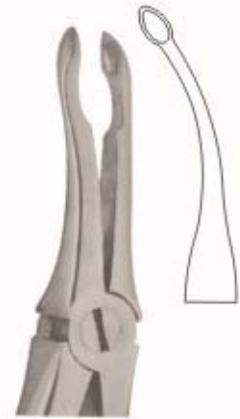

786-058
Fig. 149
Apex Forceps Upper Root
Deep Root Pick



786-059
Fig. 44



786-060
Fig. 44Z



786-061
Fig. 45Z



786-062
Fig. 46 XL
Apex Forceps Lower Root
Deep Root Pick



786-063
Fig. 67
Upper third molars



786-064
Fig. 67A
Upper third molars



786-065
Fig. 67N
Lower third molars
deep-gripping



786-066
Fig. 331
Upper roots
deep-gripping



EXTRACTING FORCEPS (English Pattern)

- Щипцы экстракционные (английская форма)
- Deviers (Forme Anglaise)
- Zahnzangen (Englische Form)
- Щипці екстракційні (англійська форма)
- Forceps de Extraccion (Forme Inglesa)
- استخراج ملقط (الانجليزية نمط)



Fig. 1
Upper laterals
and canines



786-067 Set of 10 Pieces

- Fig. 1
- Fig. 7
- Fig. 13
- Fig. 17
- Fig. 18
- Fig. 22
- Fig. 51A
- Fig. 67
- Fig. 74N
- Fig. 79

Fig. 7
Upper premolars



Fig. 13
Lower premolars



Fig. 17
Upper molars
Right



Fig. 18
Upper molars
Left



Fig. 22
Lower roots



Fig. 51A
Upper roots



Fig. 67
Upper third
molars



Fig. 74N
Lower molars



Fig. 79
Lower third
molars



EXTRACTING FORCEPS

- Щипцы экстракционные
- Deviers
- Zahnzangen

- Щипці екстракційні
- Forceps de Extraccion
- استخراج منقذ

Pediatric Tooth Extracting Forceps Set



786-068
English Pattern Klien # 51S
Pedodontic, Upper root



786-069
English Pattern Klien # 137
Pedodontic, Upper incisors spring handle



786-072
English Pattern Klien # 5
Pedodontic Lower incisors



786-070
English Pattern Klien # 139
Pedodontic Upper Premolars



Fig. # 01 to 07
Set of 7 Pieces



786-073
English Pattern Klien # 7
Pedodontic Lower roots.



786-071
English Pattern Klien # 3
Pedodontic Upper molars
universal

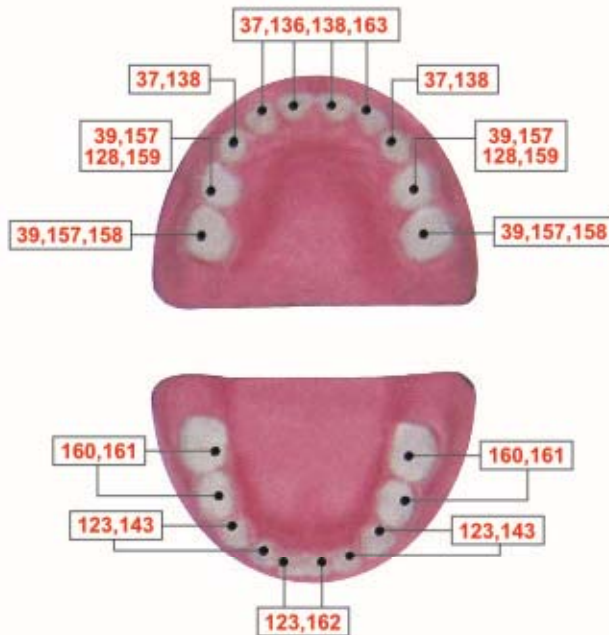

786-074
English Pattern Klien # 6
Pedodontic Lower molars,
spring handle

EXTRACTING FORCEPS (American Pattern)

- Щипцы экстракционные (американская форма)
- Deviers - forme americane
- Forceps de extracción - forma americana
- Щипці екстракційні (американська форма)
- Pinzeper per astrazione - forma americana
- استخراج منقط (النمط الأمريكي)

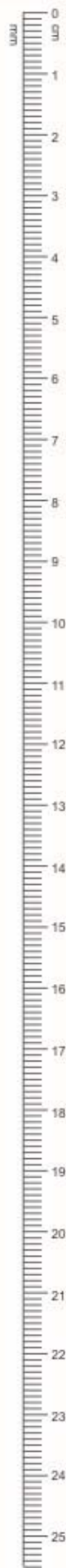

786-075
Fig. 1STD
Winter
upper centrals and canines



786-076
Fig. 1
Upper incisors and roots



786-077
Fig. 150
Cryer

EXTRACTING FORCEPS (American Pattern)

- Щипцы экстракционные (американская форма)
- Deviers - forme americane
- Forceps de extracción - forma americana
- Щипці екстракційні (американська форма)
- Pinzeta per astrazione - forma americana
- استخراج ملقط (النمط الأمريكي)



786-078
Fig. 150A
Cryer
Upper incisors Premolars roots



786-079
Fig. 62
Cryer
Incisors premolars,
deciduous teeth



786-080
Fig. 10S
Upper roots



786-081
Fig. 17
Lower molars

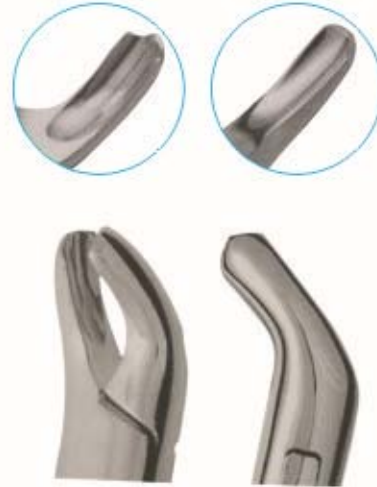

786-082
Harris
Fig. 18R



786-083
Harris
Fig. 18L

EXTRACTING FORCEPS (American Pattern)

- Щипцы экстракционные (американская форма)
- Deviers - forme americane
- Forceps de extracción - forma americana
- Щипці екстракційні (американська форма)
- Pinzoper per astrazione - forma americana
- استخراج منقذ (النمط الأمريكي)



786-084
Fig. 210
Cryer
Upper third molars



786-085
Fig. 53R
Upper molars, right



786-086
Fig. 53L
Upper molars, left

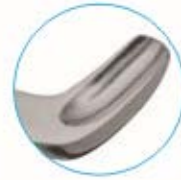

786-087
Fig. 88R
NEVIUS



EXTRACTING FORCEPS (American Pattern)

- Щипцы экстракционные (американская форма)
- Deviers (Forme americane)
- Forceps de extracción - forma americana
- Щипці екстракційні (американська форма)
- Pinzeta per astrazione - forma americana
- استخراج ملقط (النمط الأمريكي)



786-088
Fig. 24
Upper molars



786-089
Fig. 210S
Upper third molars



786-090
Fig. 210H
Upper third molars



786-091
Fig. 286
Upper roots,
Premolars, incisors



786-092
Fig. 99C
Kells
Upper incisors
canines, premolars



786-093
Fig. 222
Lower third molars



786-094
Fig. 286
Lower molars

EXTRACTING FORCEPS (American Pattern)

- Щипцы экстракционные (американская форма)
- Deviers - forme americane
- Forceps de extracción - forma americana
- Щипці екстракційні (американська форма)
- Pinzeper per astrazione - forma americana
- استخراج مالفط (النمط الأمريكي)

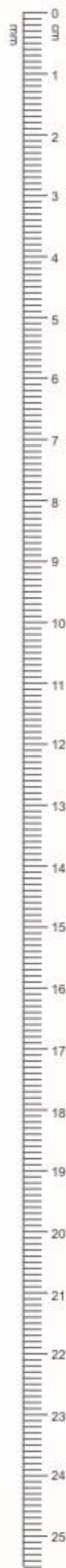

786-095
Fig. 88L
Nevius
Upper incisors, Left



786-096
Fig. 65
Upper incisors,
and roots



786-097
Fig. 32A
Parmly
Upper premolars
and roots



786-098
Fig. 32
Parmly
Upper premolars
and molars



EXTRACTING FORCEPS (American Pattern)

- Щипцы экстракционные (американская форма)
- Deviers - forme americane
- Forceps de extracción - forma americana
- Щипці екстракційні (американська форма)
- Pinzoper per astrazione - forma americana
- استخراج ملقط (النمط الأمريكي)



786-099
COHEN
Universal



786-100
Fig. 203
Lower incisors
and roots



786-101
Fig. 69
Tomes
Upper and lower roots

EXTRACTING FORCEPS (American Pattern)

- Щипцы экстракционные (американская форма)
- Deviers - forme americane
- Forceps de extracción - forma americana
- Щипці екстракційні (американська форма)
- Pinzeper per astrazione - forma americana
- استخراج ملقط (النمط الأمريكي)

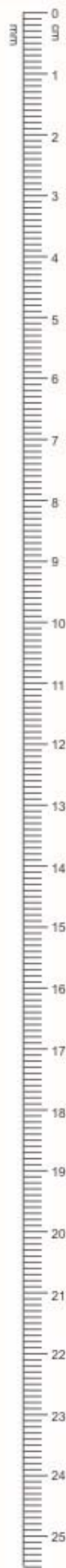

786-102
Fig. 23
Lower molars



786-103
Fig. 16
Lower molars



786-104
Fig. 5
PHYSIC
Lower third molars



786-105
Fig. 15
HARRIS
Lower molars



786-106
Fig. 103

EXTRACTING FORCEPS (American Pattern)

- Щипцы экстракционные (американская форма)
- Deviers - forme americane
- Forceps de extracción - forma americana
- Щипці екстракційні (американська форма)
- Pinzere per astrazione - forma americana
- استخراج ملقط (النمط الأمريكي)



786-109
Fig. 1
Upper Anterior

786-110
Lower Molar
Fig. 23 Cow Horn



786-111
Fig. 23
Lower Anterior



786-112
Fig. 88L
Upper Molar Left



786-113
Fig. 88R
Upper Molar Right



786-114
Fig. 74
Lower Anterior



786-115
Fig. 106
Lower Incisors



786-116
Fig. 174
Extra Narrow
Lower Anterior
Apical Retention
Forceps



786-117
Fig. 859
Lower Molar
Roots



DENTAL SYRINGES

- Шприцы стоматологические карпульные
- Seringues à usage dentaire
- Dentspritzen

- Шприці стоматологічні карпульні
- Jeringes dentales
- المحاق الأسنان



786-118 1.8ML
786-119 2.2ML

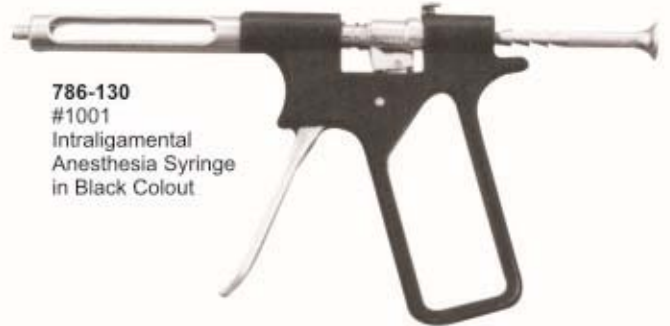

786-130
#1001
Intraligamental
Anesthesia Syringe
in Black Colour



786-120 1.8ML
786-121 2.2ML



786-131 1.8ML
786-132 2.2ML
Angled



786-122 1.8ML
786-123 2.2ML



786-133
Alumium - Dark 1.8 ML



786-124 1.8ML
786-125 2.2ML



786-134
Alumium - Silver 1.8 ML



786-126 1.8ML
786-127 2.2ML



786-135
Alumium - Orange 1.8 ML



786-128 1.8ML
786-129 2.2ML



786-136
Alumium - Green 1.8 ML



786-137
Alumium - Blue 1.8 ML

BONE RONGEURS

- Костные кусачки
- HohmeiBelangen
- Pînces-gouges

- Кусачки для кісток
- Pinzas-gubias
- روتجیورس العظام



786-138
Blumental
15cm



786-139
Blumental
15cm



786-140
Blumental
15cm



786-141
Friedman
14cm



786-142
Friedman
14.5cm



786-143
Micro-Friedman
14cm



786-144
Micro-Friedman
15cm



786-145
Micro-Friedman
16cm



786-146
Kleinert-Kutz
18.5cm



786-147
Beyer
18.5cm



786-148
Mead 1A
18.5cm



786-149
Luer
18.5cm

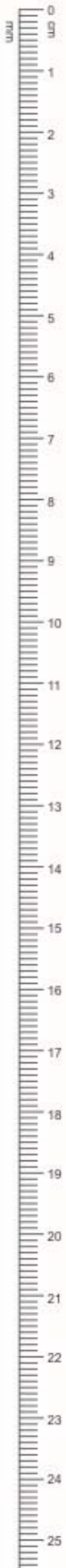

ROOT ELEVATOR

- Элеватор корневой экстракционный
- Elevateurs à racines
- Wurzelheber

- Слеватор корневий екстракційний
- Elevadores para raíces
- مصاعد الجذر



Apexo Root Elevators



Apexo



786-150
Apexo
2.5x9mm
Straight

786-151
Apexo
2.7x9mm
Straight

786-152
Apexo
3.0x9mm
Straight

786-153
Apexo
2.5x9mm
Curved

786-154
Apexo
3.0x9mm
Curved

786-155
Seldin
3.4x14mm
Straight

Luxator Root Elevators



Luxator



786-156
Luxator
3mm
Straight

786-157
Luxator
3mm
Curved

786-158
Luxator
4mm
Straight

786-159
Luxator
4mm
Curved

786-160
Luxator
5mm
Straight

786-161
Luxator
5mm
Curved

Bein Root Elevators



Bein

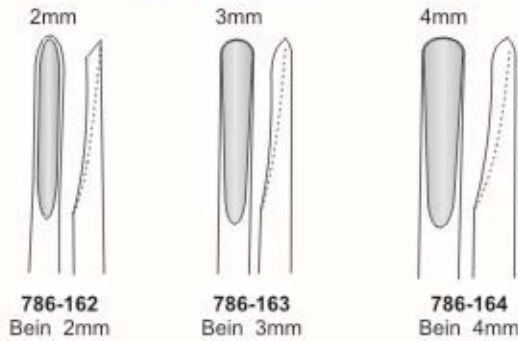

786-162
Bein 2mm

786-163
Bein 3mm

786-164
Bein 4mm

Seldin Root Elevators



Seldin

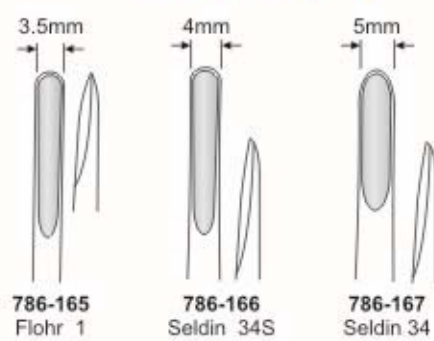

786-165
Flohr 1

786-166
Seldin 34S

786-167
Seldin 34

ROOT ELEVATOR

- Elevator corneвой экстракционный
- Elevateurs à racines
- Wurzelheber

- Elevator corneвой экстракційний
- Elevadores para raices
- مصاعد الجذر

Apexo Root Elevators



Apexo



786-168
Apexo
2.5x9mm
Straight



786-169
Apexo
2.7x9mm
Straight



786-170
Apexo
3.0x9mm
Straight



786-171
Apexo
2.5x9mm
Curved



786-172
Apexo
3.0x9mm
Curved



786-173
Seldin
3.4x14mm
Straight

Luxator Root Elevators



Luxator



786-174
Luxator
3mm
Straight



786-175
Luxator
3mm
Curved



786-176
Luxator
4mm
Straight



786-177
Luxator
4mm
Curved



786-178
Luxator
5mm
Straight



786-179
Luxator
5mm
Curved

Bein Root Elevators



Bein



786-180
Bein 2mm



786-181
Bein 3mm



786-182
Bein 4mm

Seldin Root Elevators



Seldin



786-183
Flohr 1



786-184
Seldin 34S



786-185
Seldin 34

ROOT ELEVATOR

- Elevator корневой экстракционный
- Elevateurs à racines
- Wurzelheber

- Elevator корневий екстракційний
- Elevadores para raíces
- مصاعد الجذر



Apical Root Elevators



786-186
Fig. 1
Straight



786-187
Fig. 4
Left



786-188
Fig. 5
Right

Apical Root Elevators



786-189
Fig. 2
Straight



786-190
Fig. 3
Left



786-191
Fig. 4
Right

Coupland Root Elevators



786-192
Coupland No. 1



786-193
Coupland No. 2



786-194
Coupland No. 3

Coupland

Seldin Root Elevators



786-195
Seldin 4L
Left



786-196
Seldin 4R
Right



786-197
Seldin 1L
Left



786-198
Seldin 1R
Right

Seldin
13-3
Straight



786-199
Seldin
Left



786-200
Seldin
Right

ROOT ELEVATOR

- Elevator корневой экстракционный
- Elevateurs à racines
- Wurzelheber

- Elevator corneviu extracționii
- Elevadores para raíces
- مصاعد الجذر

Apical Root Elevators



Apical Root Elevators



Coupland Root Elevators

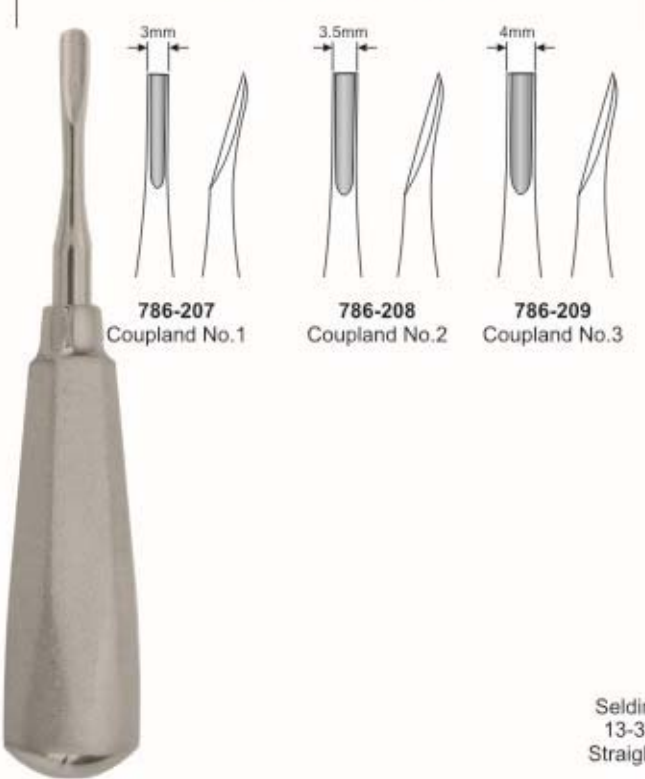

Seldin Root Elevators

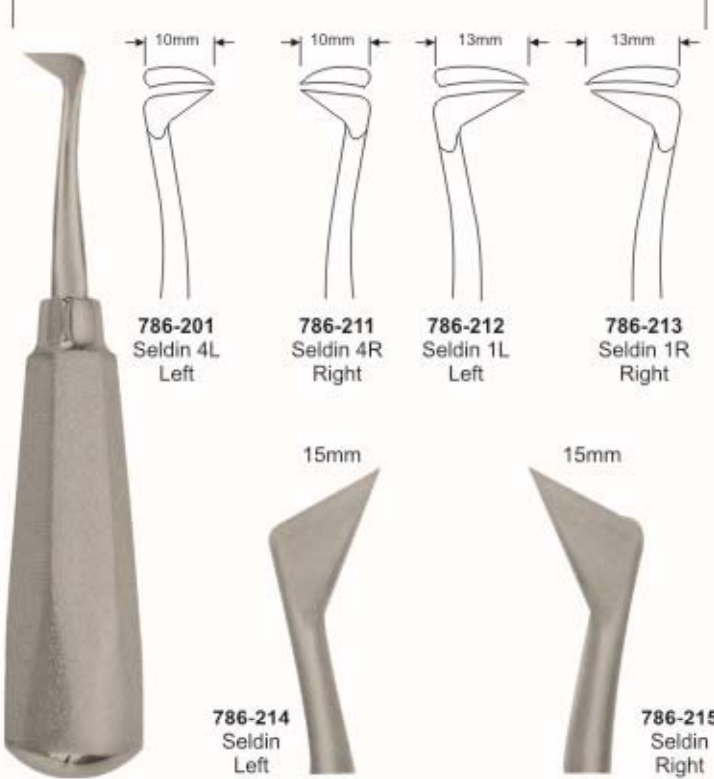

ROOT ELEVATOR

- Elevator корневой экстракционный
- Elevateurs à racines
- Wurzelheber

- Elevator корневий экстракційний
- Elevadores para raíces
- مصاعد الجذر



Apical Root Elevator

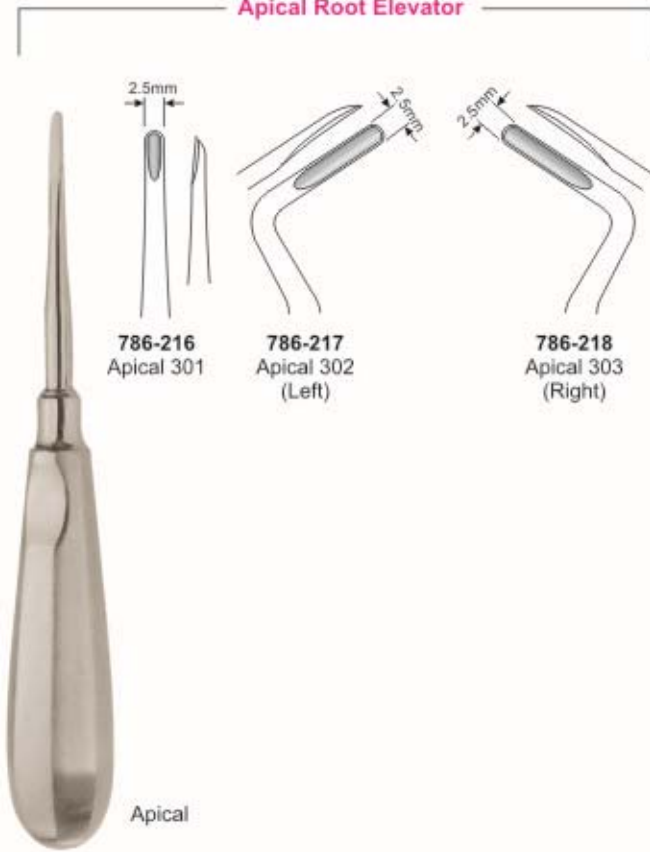

786-217
Apical 302
(Left)

786-218
Apical 303
(Right)

Apical Root Elevator



Apical Root Elevator



Laxutor Root Elevator



ROOT ELEVATOR

- Elevator корневой экстракционный
- Elevateurs à racines
- Wurzelheber

- Elevator корневий экстракційний
- Elevadores para raíces
- مساعد الجذر

Lindo Levian Root Elevator

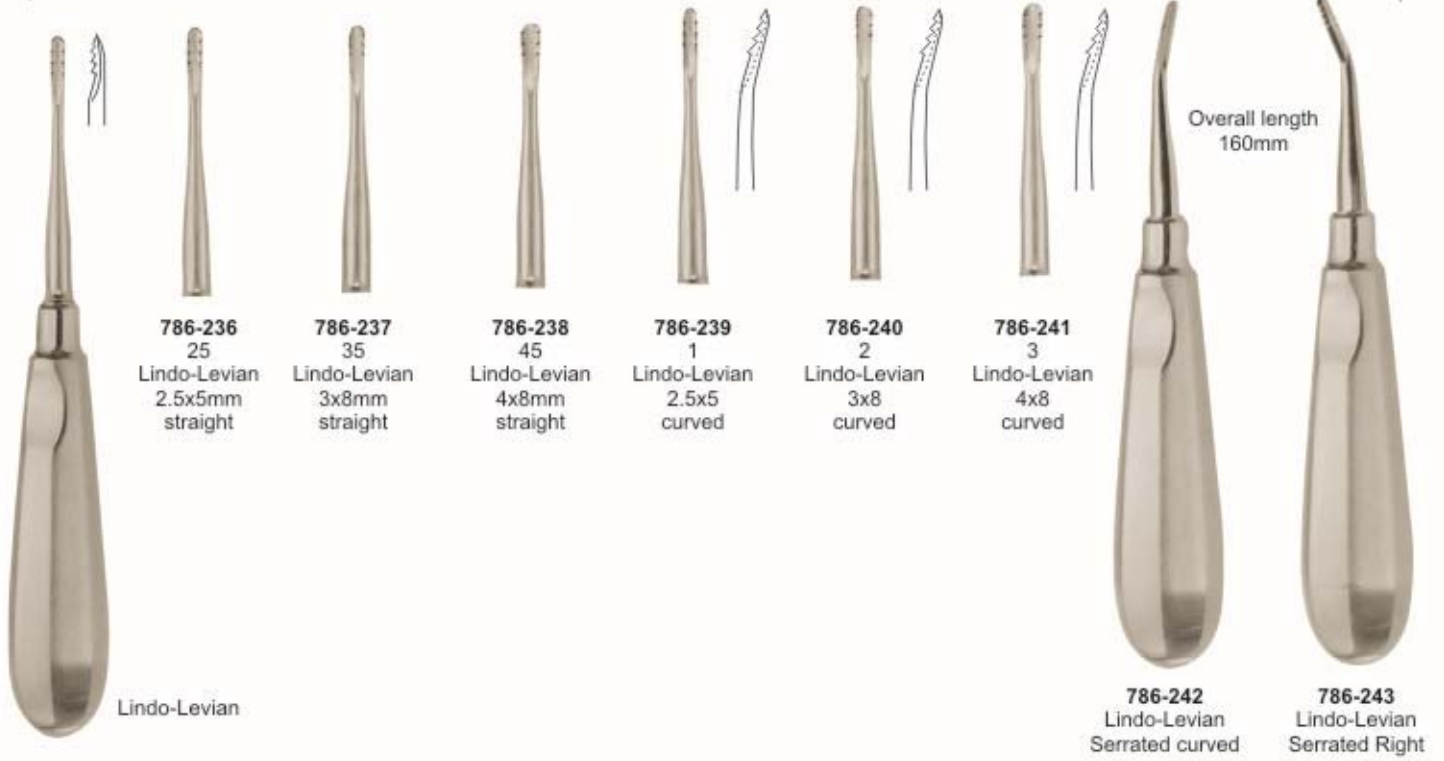

Flohr Root Elevator



Heidbrink Root Elevator

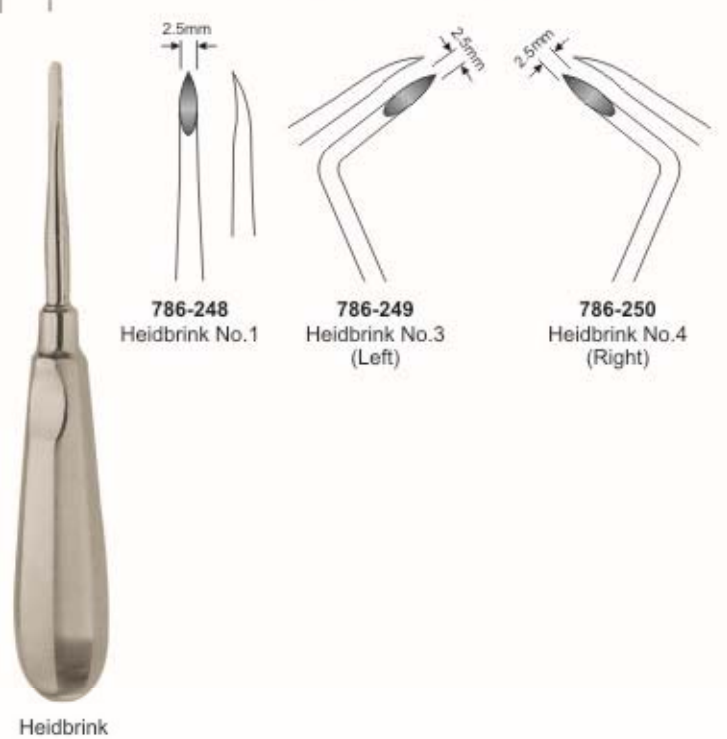

ROOT ELEVATOR

- Elevator корневой экстракционный
- Elévateurs à racines
- Wurzelheber

- Elevator корневий екстракційний
- Elevadores para raíces
- مصاعد الجذر



Friedmann Roots Elevator



786-251 Friedmann 4F Str
786-252 Friedmann 5F Left
786-253 Friedmann 6F Right

Heidbrink Roots Elevator



786-254 Heidbrink Straight
786-255 Heidbrink Left
786-256 Heidbrink Right

Wisdom Roots Elevator



786-257 Wisdom for 18 and 38
786-258 Wisdom for 28 and 48

Bayonet Roots Elevator (Set)



786-259 Left
786-260 Right
786-261 Bayonet
786-262 Curved
786-263 Straight

Luxator Roots Elevator



786-264 Luxator Straight
786-265 Luxator Curved

ROOT ELEVATOR

- Elevator корневой экстракционный
- Elévateurs à racines
- Wurzelheber

- Elevator корневий екстракційний
- Elevadores para raíces
- مصاعد الجذر

Roots Elevator



Luxier Roots Elevator



Luxier Roots Elevator



Claw-Lift Roots Elevator



ROOT ELEVATOR

- Элеватор корневой экстракционный
- Elévateurs à racines
- Wurzelheber

- Елеватор кореневий екстракційний
- Elevadores para raíces
- مصاعد الجذر

Hysin Roots Elevator



Cryer Roots Elevator



Kopp Roots Elevator



ROOT ELEVATOR

- Elevator корневой экстракционный
- Elévateurs à racines
- Wurzelheber

- Elevator корневий экстракційний
- Elevadores para raíces
- مصاعد الجذر

Kopp Roots Elevator



786-295
KOPP
Right

786-296
KOPP
Left

Heber Roots Elevator



786-297
Heber
Bayonet

786-298
Heber
Bayonet

Bein Roots Elevator



786-299
Bein
3mm

786-300
Bein
4mm

Bein Roots Elevator



786-302
2mm
Straight
serrated

786-303
3mm
Straight

786-304
4mm
Curved

786-306
2mm
Straight
serrated

786-307
3mm
Straight

786-308
4mm
Curved

786-310
2mm
Straight
serrated

786-311
3mm
Straight

786-312
4mm
Curved

786-301
Bein
2mm, curved
serrated

786-305
Bein
2mm, curved
serrated

786-309
Bein
2mm, curved
serrated

ROOT ELEVATOR

- Элеватор корневой экстракционный
- Elévateurs à racines
- Wurzelheber

- Єлеватор кореневий екстракційний
- Elevadores para raíces
- مصاعد الجذر



Seldin Roots Elevator



W Barry Roots Elevator



Winter Roots Elevator



Pott Roots Elevator



ROOT ELEVATOR

- Elevator корневой экстракционный
- Elevateurs à racines
- Wurzelheber

- Elevator коренный экстракционный
- Elevadores para raices
- مصاعد الجذر

Heidbrink Roots Elevator

Syndesmotomes Roots Elevator



786-338
Heidbrink
Straight

786-339
Heidbrink
Left

786-340
Heidbrink
Right

786-341
Heidbrink
Straight

786-342
Heidbrink
Left

786-343
Heidbrink
Right

786-344
Straight

786-345
Left

786-346
Right

Periotome Roots Elevator

Syndesmotomes



786-347
Periotome
2.1mm
Straight

786-348
Periotome
2.6mm
Straight

786-349
Periotome
2.1mm
Angular

786-350
Periotome
2mm
Curved

786-351
Periotome
2.0mm

786-352
Periotome
2.5mm

786-353
Periotome
3.0mm

786-354
Periotome
4.0mm

ROOT ELEVATORS

- Элеватор корневой экстракционный
- *Élévateurs à racines*
- Wurzelheber

- Єлеватор кореневий екстракційний
- *Elevadores para raíces*
- مصاعد الجذر



786-355
1S
(Straight 1mm)



786-356
2S
(Straight 2mm)



786-357
3S
(Straight 3mm)



786-358
5S
(Straight 5mm)



786-359
3C
(Curved 3mm)



786-360
5C
(Curved 5mm)



786-361
3CA
(Curved Angle 3mm)



786-362
3C
(Inverted Curved 3mm)



786-363
DE 3
(Dual Edge 3mm / 1.5mm)



786-364
DE 5
(Dual Edge 5mm / 3mm)

ROOT ELEVATOR

- Elevator корневой экстракционный
- Elevateurs à racines
- Wurzelheber

- Elevator корневий экстракційний
- Elevadores para raices
- مصاعد الجذر

PDL ELEVATORS



786-365
PDL Elevators
Set of 7 Pcs

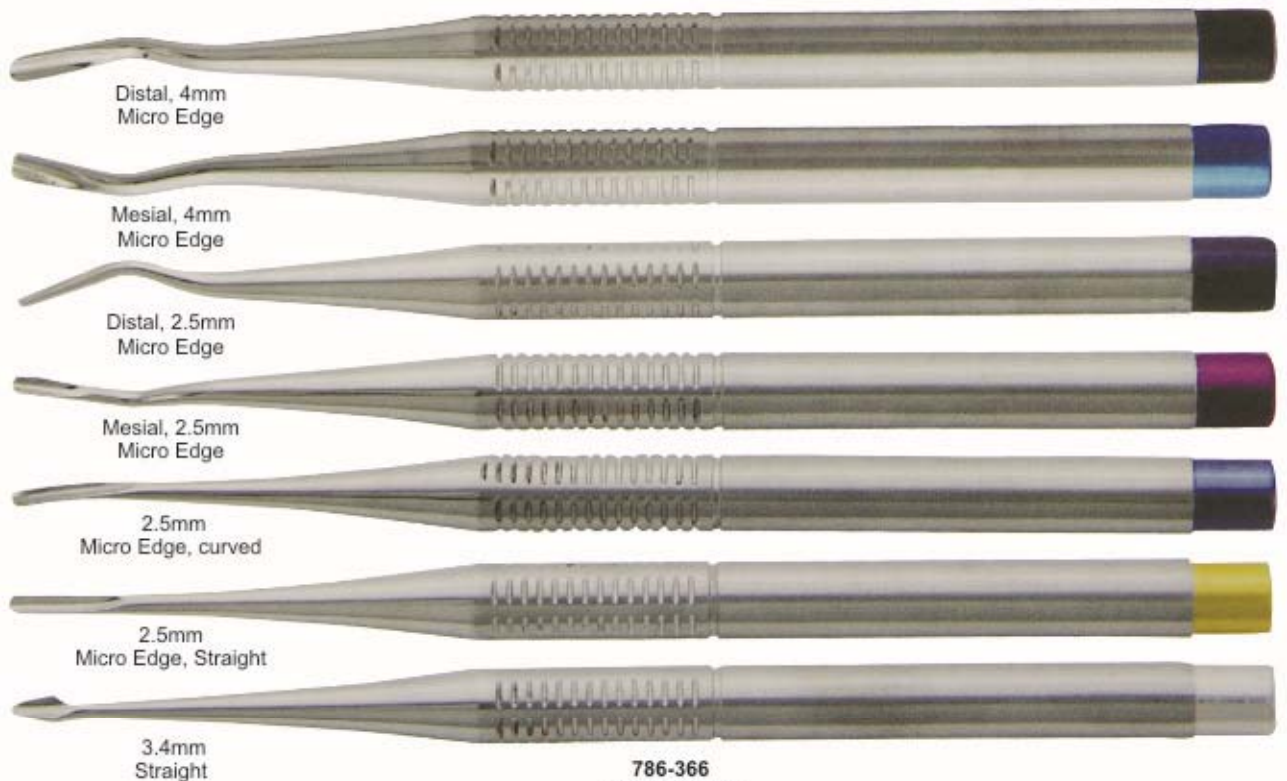

786-366
PDL Elevators
Set of 7 Pcs

ROOT ELEVATOR

- Злеватор корневой экстракционный
- Elévateurs à racines
- Wurzelheber

- Elevator coronevii ekstraktsionnyi
- Elevadores para raíces
- مصاعد الجذر

PDL ELEVATORS

Delicate Arrow tip

Luxivators straight
Atraumatic luxation of the tooth

Luxivators curved
Atraumatic luxation of the tooth



4,0mm
straight

4,0mm
curved



2,5mm
straight

3,5mm
straight

4,5mm
straight



2,5mm
curved

3,5mm
curved

4,5mm
curved

786-367
PDL Elevators
Set of 8 Pcs



Our Scalers

Compare our scalers and curettes with the best in the industry and you will immediately recognize we are equal in every way but one...price. Note the deep precision knurling for better tactile feel. The same high-grade stainless steel tips, The same light weight (under 18 grams) for less hand fatigue, the same professional craftsmanship, and surpassing the highest industry standards. Of course, any manufacturer can make these claims, but we guarantee and certify ours.

Healthy

Periodontal Disease

Healthy Gums

Periodontal Prob

Healthy Attachment and Bone Levels

Plaque Bacteria Biofilm

Calculus / Tartar

Periodontal Pocke

Reduced Attachment and Bone Level

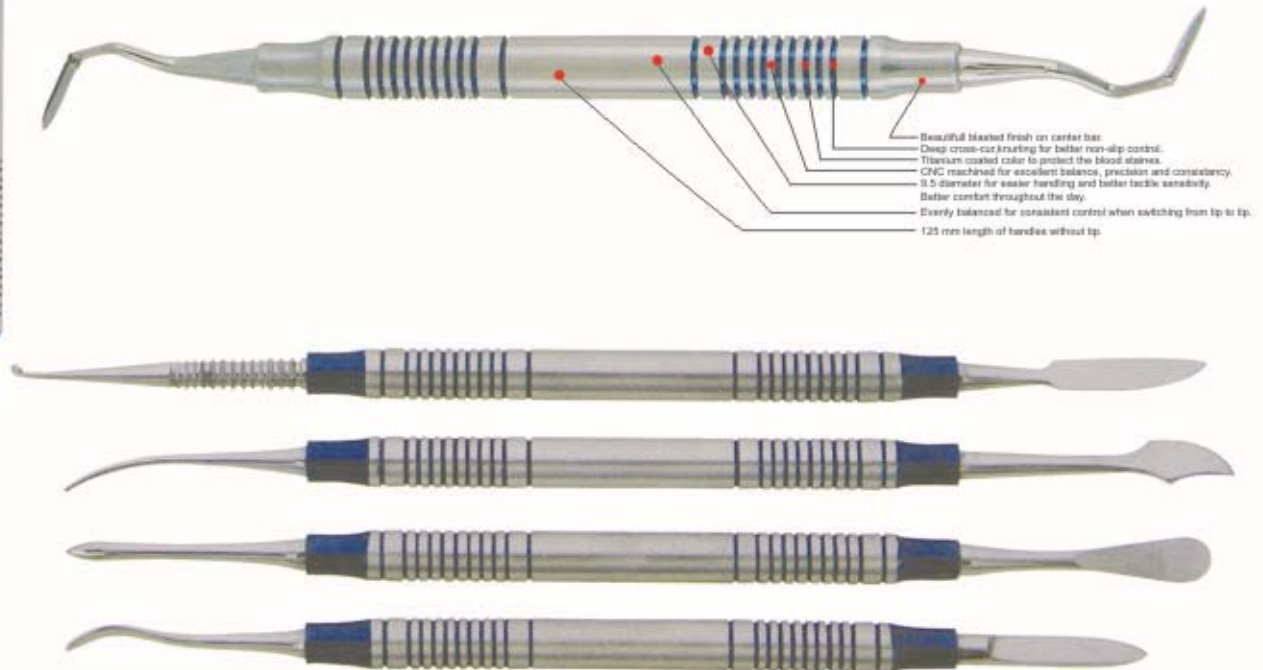
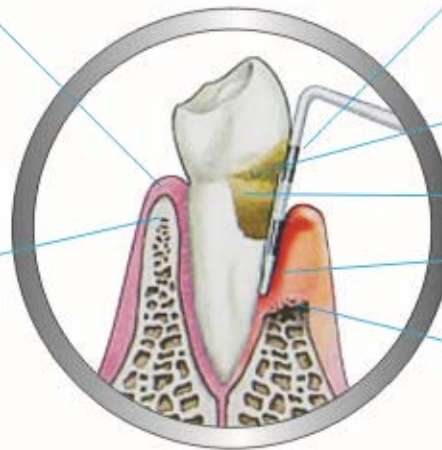

- High-polish mirror finish tips.
- Manufactured within the guidelines of the FDA quality assurance system for good manufacturing practices.
- Highest grade German stainless steel, razor sharp, durable tips. Rockwell hardened to 60 Rhc.
- 27 of the most popular designs from graceys to McCalls to columbias, and many european patterns.
- All Instruments are guaranteed against defects in material and workmanship.

- All instruments bear the ce mark, emblematic of the european community's highest standards.
- Customer satisfaction guarantee, too!
- Less than 20 grams...Lightweight for less hand fatigue.
- Manufactured to the most exacting standards so the 50th instrument you buy is exactly like your first.
- You decide ...Why pay more for the same high-quality instruments?



HANDLES FOR MOUTH MIRRORS

- Ручки для зеркал
- Manches pour miroirs à bouche
- Mundspiegelgriffe

- Ручки для дзеркал
- Mangos para espejos debica
- مقبض مرآة الفم



Magnifying



Plain



Rhodium

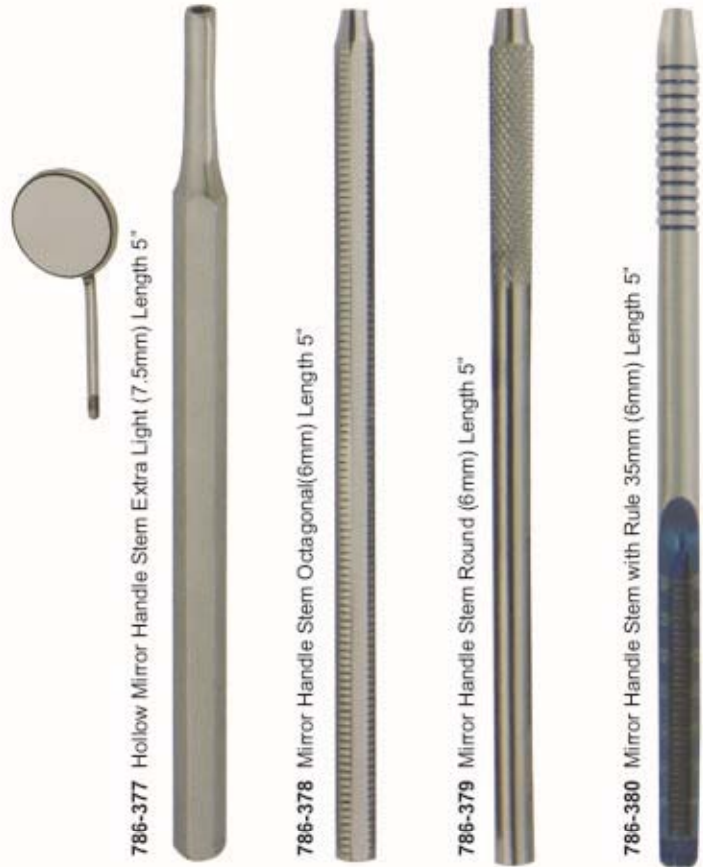

TWEEZERS

- Пинцеты
- Pincettes - Brucelles
- Zahnpinzetten

- Пінцети
- Pinzas para algodón
- ملاقط

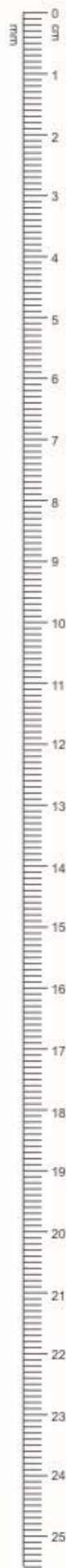

786-381
Surgical
11.5cm



786-382
London College
15cm



786-383
Semken Taylor
Str.



786-384
Semken Taylor
Cvd.



786-385
Meriam
16cm



786-386
Dressing
14cm



786-387
Semken Taylor
1x2 Straight



786-388
Semken Taylor
1x2 Curved



786-389
Gillies
15cm 1x2



786-390
14cm 1x2



786-391
Perry
13cm



786-392
Atraumatic
15cm Cvd.



786-393
Atraumatic
15cm Str.



786-394
College with Lock
15cm Cvd.



786-395
Gerald
17.5cm



786-396
with Lock
15cm



786-397
Atraumatic
17.5cm

TWEEZERS

- Пинцеты
- Precelles - Brucelles
- Zahnpinzetten

- Пінцети
- Pinzas para algodón
- ملاقط



786-398
Adson-TC
12cm



786-399
Adson-TC
12cm 1x2



786-400
Adson-TC
15cm 1x2



786-401
Adson
12cm



786-402
Adson
12cm 1x2



786-403
Adson
15cm 1x2



786-404
Adson Brown
12cm



786-405
Crane Kaplan
15cm



786-406
Crane Kaplan
15cm



786-407
Crane Kaplan
15cm



786-408
Hemingway
15cm



786-409
Miller
15cm Str.



786-410
Miller
15cm Cvd.



786-411
Dressing Tweezer
14.5cm



786-412
College Curved
Tip 15cm



786-413
Maryam Tweezers
15cm



786-414
College Tweezer
15cm



786-415
Perry Tweezer
12.5cm



786-416
Self-locking
Tweezer
15cm

EXPLORERS

- Зонды
- Зонди
- Sondes
- Sondas
- Zahnsonden
- المستكشفين

Single Ended Probe Solid Handle 4.5mm Length 150mm



Fig. 2
Normal Handle

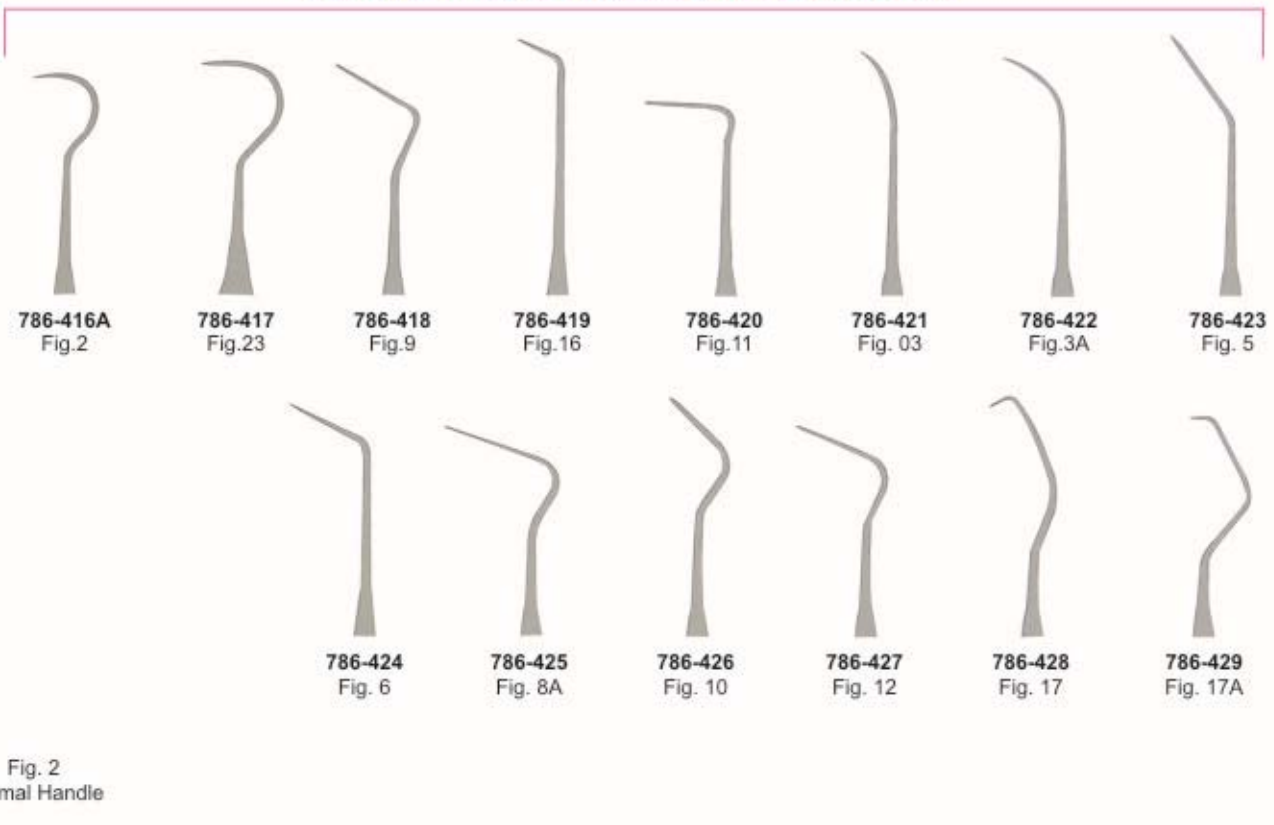

786-416A
Fig.2

786-417
Fig.23

786-418
Fig.9

786-419
Fig.16

786-420
Fig.11

786-421
Fig. 03

786-422
Fig.3A

786-423
Fig. 5

786-424
Fig. 6

786-425
Fig. 8A

786-426
Fig. 10

786-427
Fig. 12

786-428
Fig. 17

786-429
Fig. 17A

Single Ended Probe Hollow Handle 8.5mm Length 150mm



Fig. 2
Anatomic Handle



786-430
Fig. 2

786-431
Fig. 23

786-432
Fig. 9

786-433
Fig. 16

786-434
Fig. 11

786-435
Fig. 03

786-436
Fig. 3A

786-437
Fig. 5

786-438
Fig. 6

786-439
Fig. 8

786-440
Fig. 8A

786-441
Fig. 10

786-442
Fig. 12

786-443
Fig. 17

786-444
Fig. 17A

EXPLORERS

- Зонды
- Sondes
- Zahnsonden

- Зонди
- Sondas
- المستكشفين

Probes Single End Solid Handle 6mm, length 150mm



786-445
Fig. 0

786-446
Fig. 8

786-447
Fig. 9

786-448
Fig. 16

786-449
Fig. 23

Probes Single Ended 6mm, length 150mm



786-450 Perio Probe Williams

786-451 Perio Probe WHO

786-452 Perio Probe 11

786-453 Perio Probe 12

Examination Kit Set of 3 Pieces



786-454
Probe

786-455
Mirror

786-456
College Forcep
15cm

Examination Set of 4 Pieces



Examination Set of 4 Pieces



786-457
Exp,23/17-A

786-458
Excavators

786-459
Tweezers

786-460
Mouth Mirror



EXPLORERS

EXPLORERS INSTRUMENTS
SOLID HANDLE 6MM LENGTH 170MM

■ Зонды
■ Sondes
■ Zahnsonden

■ Зонди
■ Sondas
■ المستكشفين

Double Ended Explorers

Explorers

Explorers
Single End

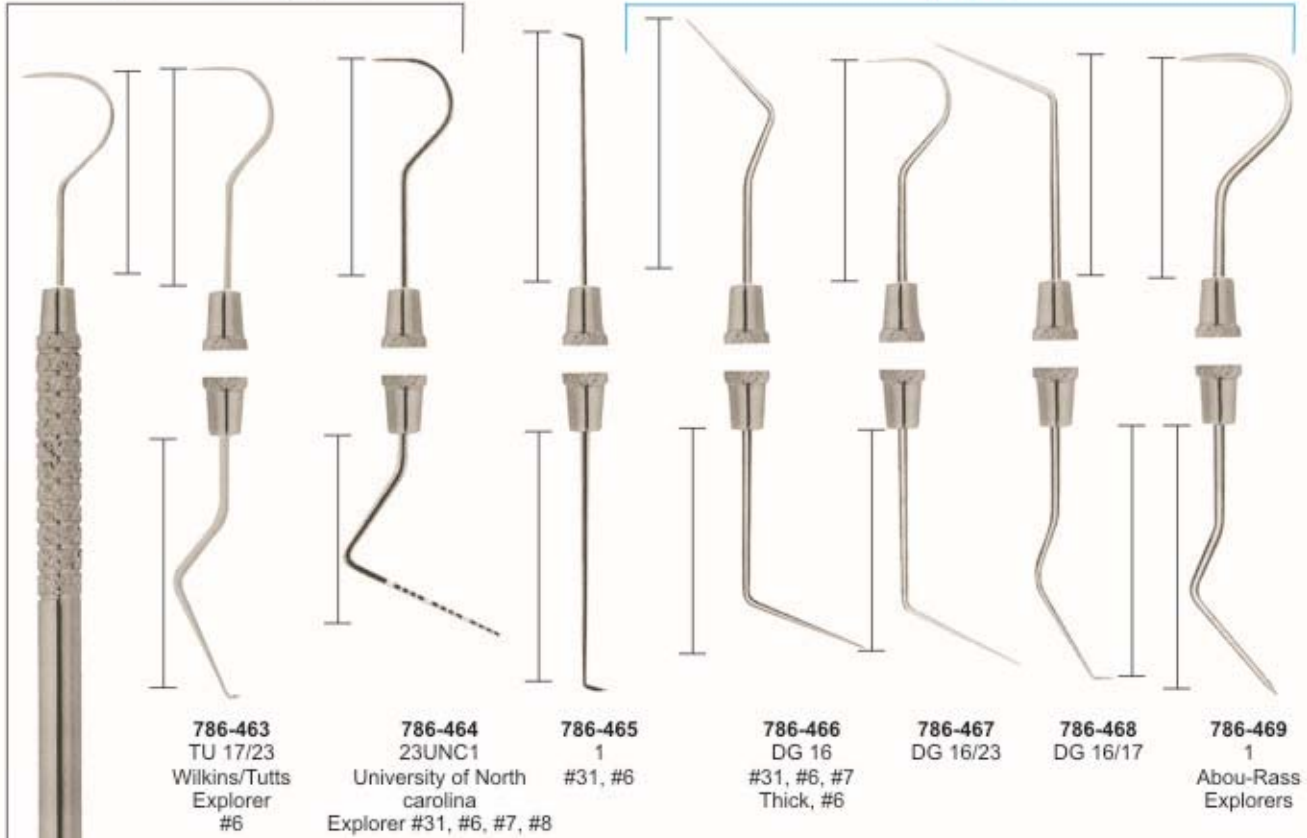

786-463
TU 17/23
Wilkins/Tutts
Explorer
#6

786-464
23UNC1
University of North
carolina
Explorer #31, #6, #7, #8

786-465
1
#31, #6

786-466
DG 16
#31, #6, #7
Thick, #6

786-467
DG 16/23

786-468
DG 16/17

786-469
1
Abou-Rass
Explorers

Probes Double Ended 6mm, length 170mm

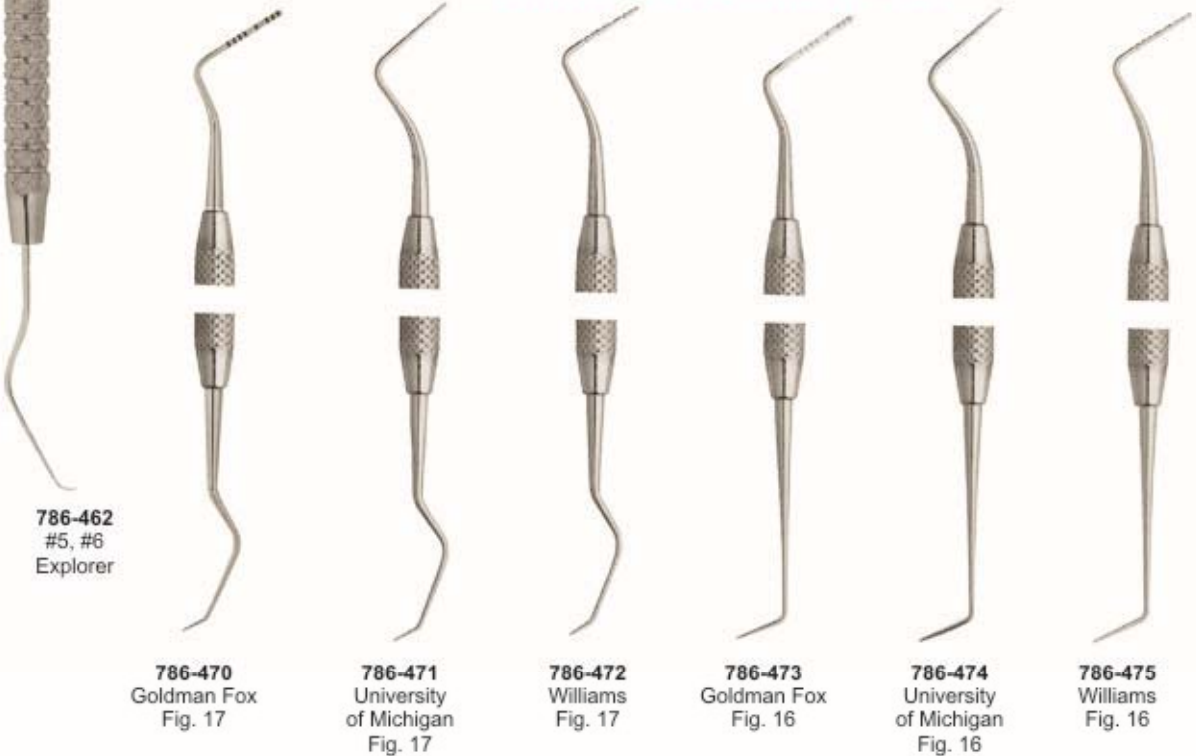

786-461
23
Shepherd's
Hook
Explorer
#30, #6, #7, #8

786-462
#5, #6
Explorer

786-470
Goldman Fox
Fig. 17

786-471
University
of Michigan
Fig. 17

786-472
Williams
Fig. 17

786-473
Goldman Fox
Fig. 16

786-474
University
of Michigan
Fig. 16

786-475
Williams
Fig. 16

EXPLORERS

■ Зонды
 ■ Sondes
 ■ Zahnsonden

■ Зонди
 ■ Sondas
 ■ المستكشفين

Pointed Probes Single Ended Handle 6mm, length 150mm



Pointed Probes Single Ended Handle 6mm, length 170mm

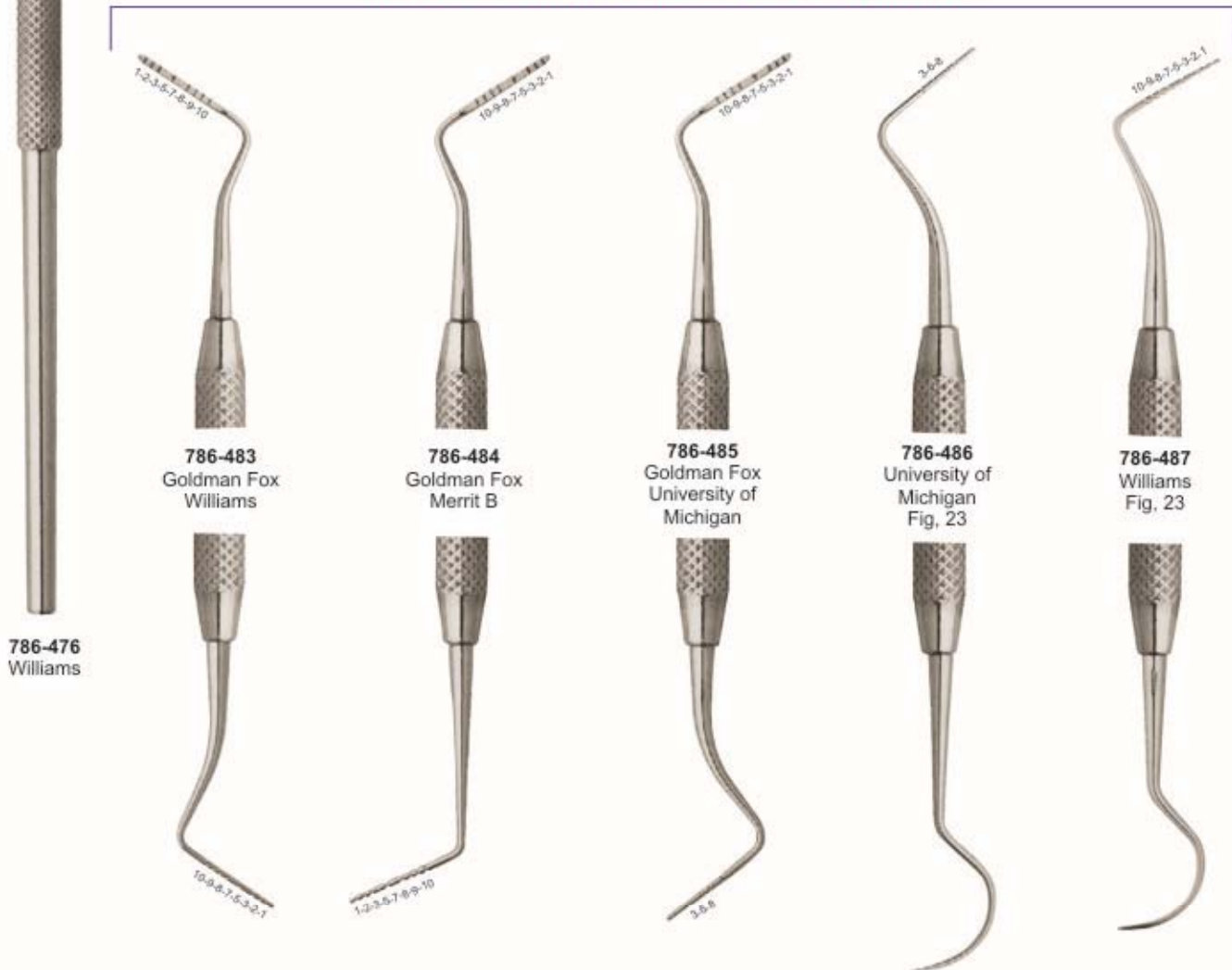

PERIODONTAL INSTRUMENTS

- Инструменты пародонтологические
- Instruments pour la parodontologie
- Instrumente für die parodontologie

- Инструменти пародонтологічні
- Instrumentos para periodoncia
- المصكوك اللثة

PERIODONTAL SET OF 10 PIECES SOLID HANDLE 6MM LENGTH 170MM



786-488 Mouth Mirror



786-489 Exp,23/17-A



786-490 Excavators



786-491 Filling Instruments



786-492 EXP,23/CP -18



786-493 EXP,23/CP -QW



786-494 EXP,23/CP -11



786-495 EXP,23/CP -10



786-496 EXP,23/CP -12



786-497 EXP,23/CP -11.5-B

EXPLORERS

- Зонды
- Sondes
- Zahnsonden

- Зонди
- Sondas
- المستكشفين

WILLIAM PROBE SET DOUBLE ENDED WITH HOLLOW HANDLE 9.5MM, LENGTH 170MM
CERMIC COATED HANDLE

Proper care must be given during cleaning, sharpening and sterilization to preserve design and integrity and to prolong usefulness. Do not expose instruments to sterilization temperatures above 350 F/177 C or to higher than recommended chemical concentrations.

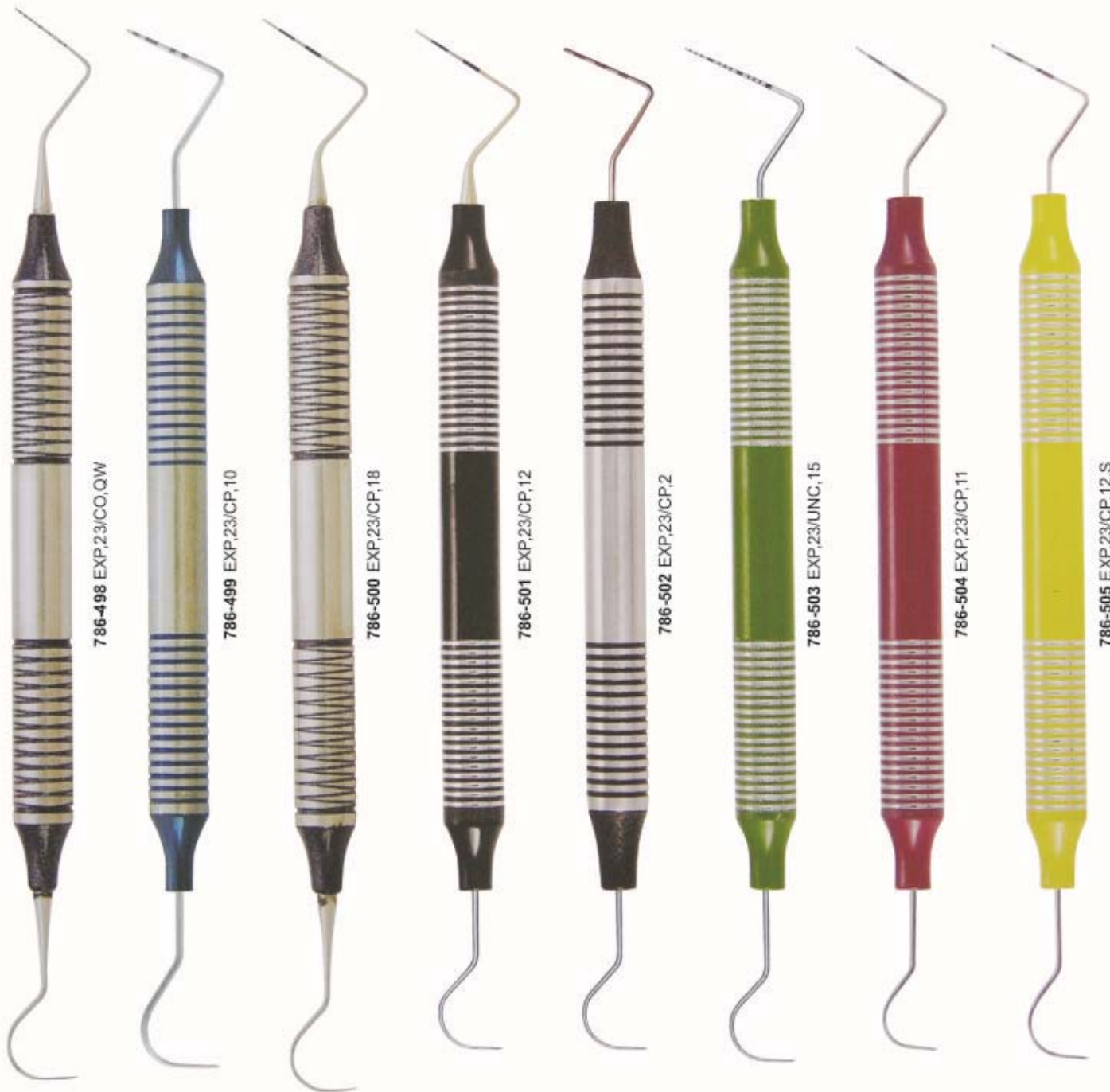

PERIODONTAL INSTRUMENTS

■ Инструменты пародонтологические
■ Instruments pour la parodontologie
■ Instrumente für die parodontologie

■ Инструменти пародонтологічні
■ Instrumentos para periodoncia
■ الصكروك اللثة

PERIODONTAL INSTRUMENTS SET OF 11 PCS
SOLID HANDLE 6MM, LENGTH 170MM



CURETTES

■ Кюрети
■ Curetas
■ Küretten

■ Кюрети
■ Curette
■ کرتس

GRACEY SET OF 7 PCS HOLLOW HANDLE 9.5MM, LENGTH 170MM

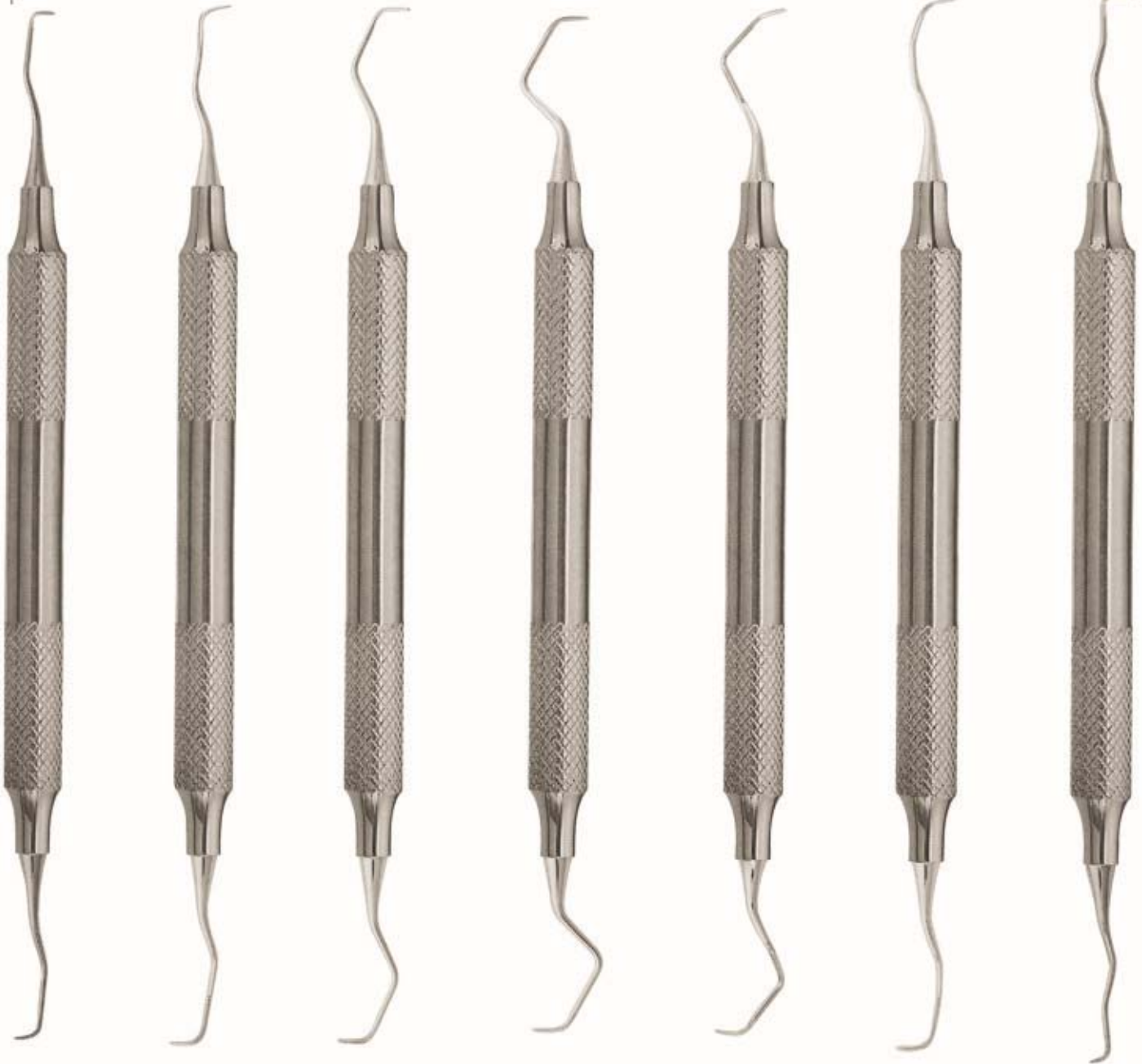

786-517
GRACEY
1/2

786-518
GRACEY
3/4

786-519
GRACEY
5/6

786-520
GRACEY
7/8

786-521
GRACEY
9/10

786-522
GRACEY
11/12

786-523
GRACEY
13/14

CURETTES

■ Кюрети
■ Curetas
■ Küretten

■ Кюрети
■ Curette
■ کرتس

GRACEY SET OF 7 PCS
HOLLOW HANDLE 9.5MM, LENGTH 170MM WITH SILICON GRIP



786-524
GRACEY
1/2



786-525
GRACEY
3/4



786-526
GRACEY
5/6



786-527
GRACEY
7/8



786-528
GRACEY
9/10



786-529
GRACEY
11/12



786-530
GRACEY
13/14

CURETTES

■ Кюрети
■ Curetas
■ Küretten

■ Кюрети
■ Curette
■ كورتيس

GRACEY MINI FIVE

HOLLOW HANDLE 9.5MM, LENGTH 170MM
CERAMIC COATED HANDLE



786-531 Gracey 1/2
786-532 Gracey 3/4
786-533 Gracey 5/6
786-534 Gracey 7/8
786-535 Gracey 11/12
786-536 Gracey 13/44

GRACEY AFTER FIVE

HOLLOW HANDLE 9.5MM, LENGTH 170MM
CERAMIC COATED HANDLE



786-537 Gracey 1/2 AF
786-538 Gracey 3/4 AF
786-539 Gracey 5/6 AF
786-540 Gracey 7/8 AF
786-541 Gracey 11/12 AF
786-542 Gracey 13/14 AF

Proper care must be given during cleaning, sharpening and sterilization to preserve design and integrity and to prolong usefulness. Do not expose instruments to sterilization temperatures above 350 F/177 C or to higher than recommended chemical concentrations.



CURETTES

■ Кюрети
■ Curetas
■ Küretten

■ Кюрети
■ Curette
■ کرتس

GRACEY CURETTE HOLLOW HANDLE 10MM, LENGTH 170MM

Curettes Set of 8 Pieces

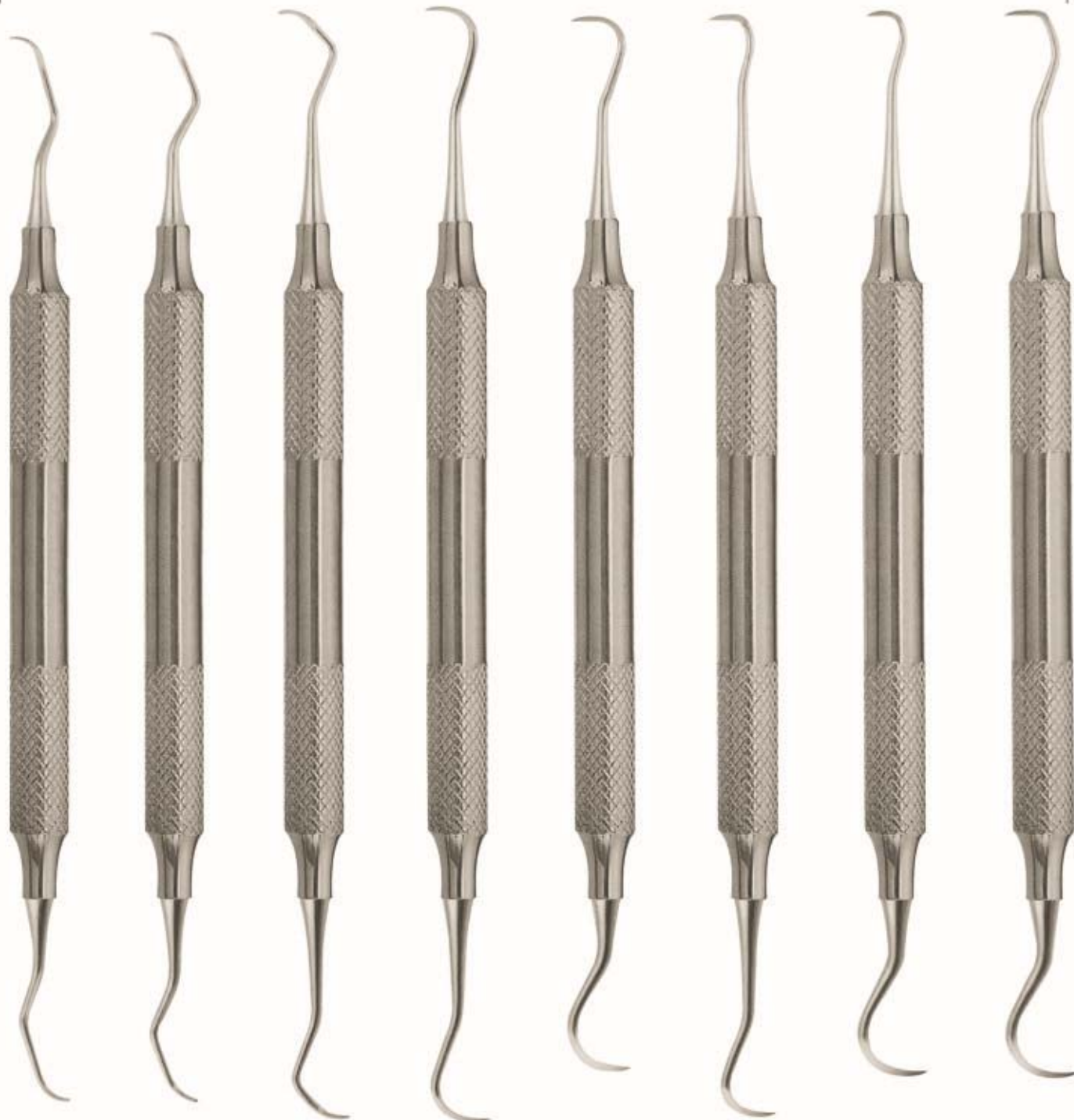

786-543
Curette
Columbia
2L-2R

786-544
Curette
Columbia
4L-4R

786-545
Curette
McCall
13S-14S

786-546
H6-H7
Scaler
Sickle

786-547
H5-U15
Scaler
Sickle

786-548
H5-13
Scaler
Sickle

786-549
U15-30
Scaler
Sickle

786-550
U15-33
Scaler
Sickle

FILLING INSTRUMENTS

- Инструменты для реставрации
- Instruments pour plombage
- Füllungsinstrumente (mit Kontrawinkel)

- Инструменти для реставрації
- Instrumentos para obturaciones
- من، الصكرک

FILLING INSTRUMENTS (Gold Pointed)
SOLID HANDLE 6MM, LENGTH 170MM

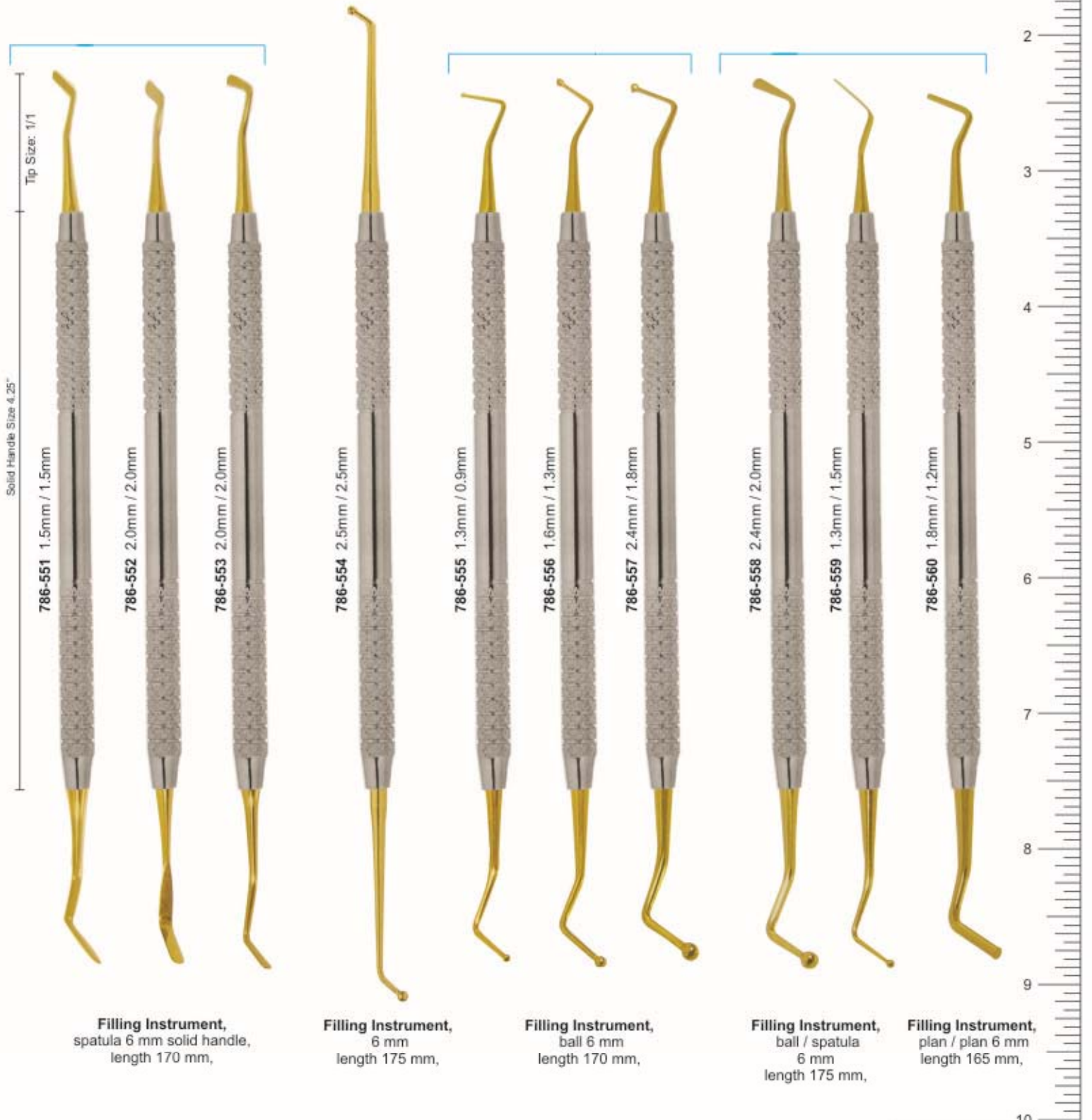

Filling Instrument,
spatula 6 mm solid handle,
length 170 mm,

Filling Instrument,
6 mm
length 175 mm,

Filling Instrument,
ball 6 mm
length 170 mm,

Filling Instrument,
ball / spatula
6 mm
length 175 mm,

Filling Instrument,
plan / plan 6 mm
length 165 mm,

EXPLORERS

■ Зонды
■ Sondes
■ Zahnsonden

■ Зонди
■ Sondas
■ المستكشفين

EXPLORERS INSTRUMENTS SOLID HANDLE 6MM, LENGTH 170MM

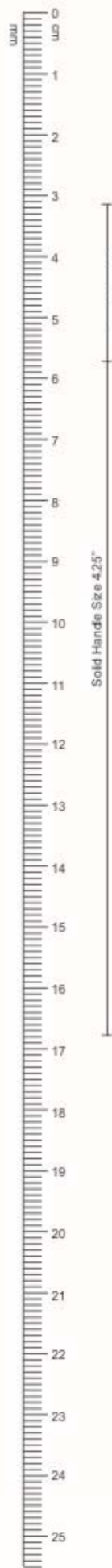

PLUGGERS

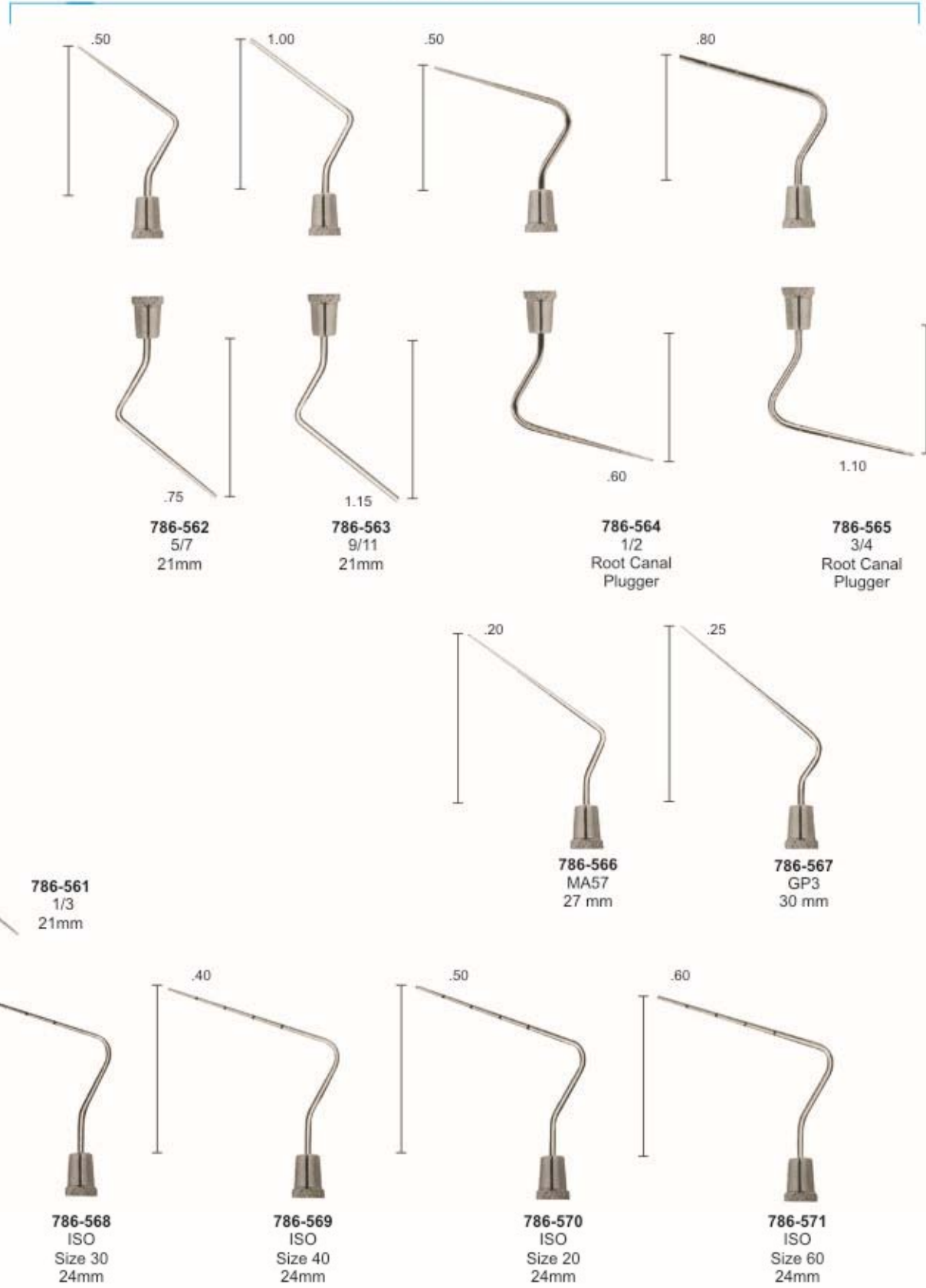

PERIODONTAL PROBES

- Зонды пародонтологические
- Sondes paradontales
- Sonde paradontali

- зонди пародонтологічні
- Sondas paradontales
- المسابير اللثة



SPREADERS



- 786-573**
ISO
Size 40
24mm
- 786-574**
ISO
Size 50
28mm
- 786-575**
ISO
Size 60
29mm

HEAT CARRIERS



- 786-576**
GP1
20mm
- 786-577**
1S
Wakal
22mm
- 786-578**
2S
Wakal
22mm
- 786-579**
D11
Standard
23mm
- 786-580**
D11S
Thin
23mm

HEAT CARRIERS



- 786-581**
D11T
Thinner
22mm
- 786-582**
D11TS
Thinnest
21mm
- 786-583**
3
28mm
- 786-584**
GP2
25mm
- 786-585**
0±
25mm
- 786-586**
00±
25mm

786-572
ISO
Size 30
24mm

PERIODONTAL PROBES

- Зонды пародонтологические
- Sondes parodontales
- Sonde parodontali

- зонди пародонтологічні
- Sondas parodontales
- المساطر اللثة

ENDODONTICS INSTRUMENTS

ANTERIOR

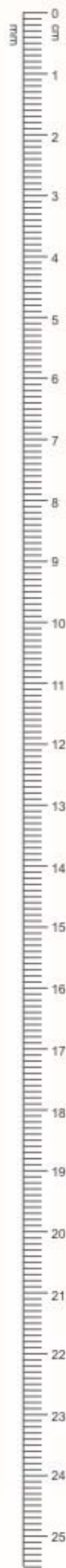

786-587
8A
29mm



786-588
8 1/2A
29mm



786-589
9A
29mm



786-590
9 1/2A
29mm



786-591
10A
29mm



786-592
10 1/2A
29mm



786-593
11A
29mm



786-594
11 1/2A
29mm



786-595
12A
29mm

LUKS



786-596
L1
18mm



786-597
L2
18mm



786-598
L3
18mm



786-599
L4
18mm

PERIODONTAL PROBES

- Зонды пародонтологические
- Sondes parodontales
- Sonde paradontali

- зонди пародонтологічні
- Sondas parodontales
- المسابير اللثة

ENDODONTICS INSTRUMENTS SOLID HANDLE 6MM, LENGTH 170MM

POSTERIOR

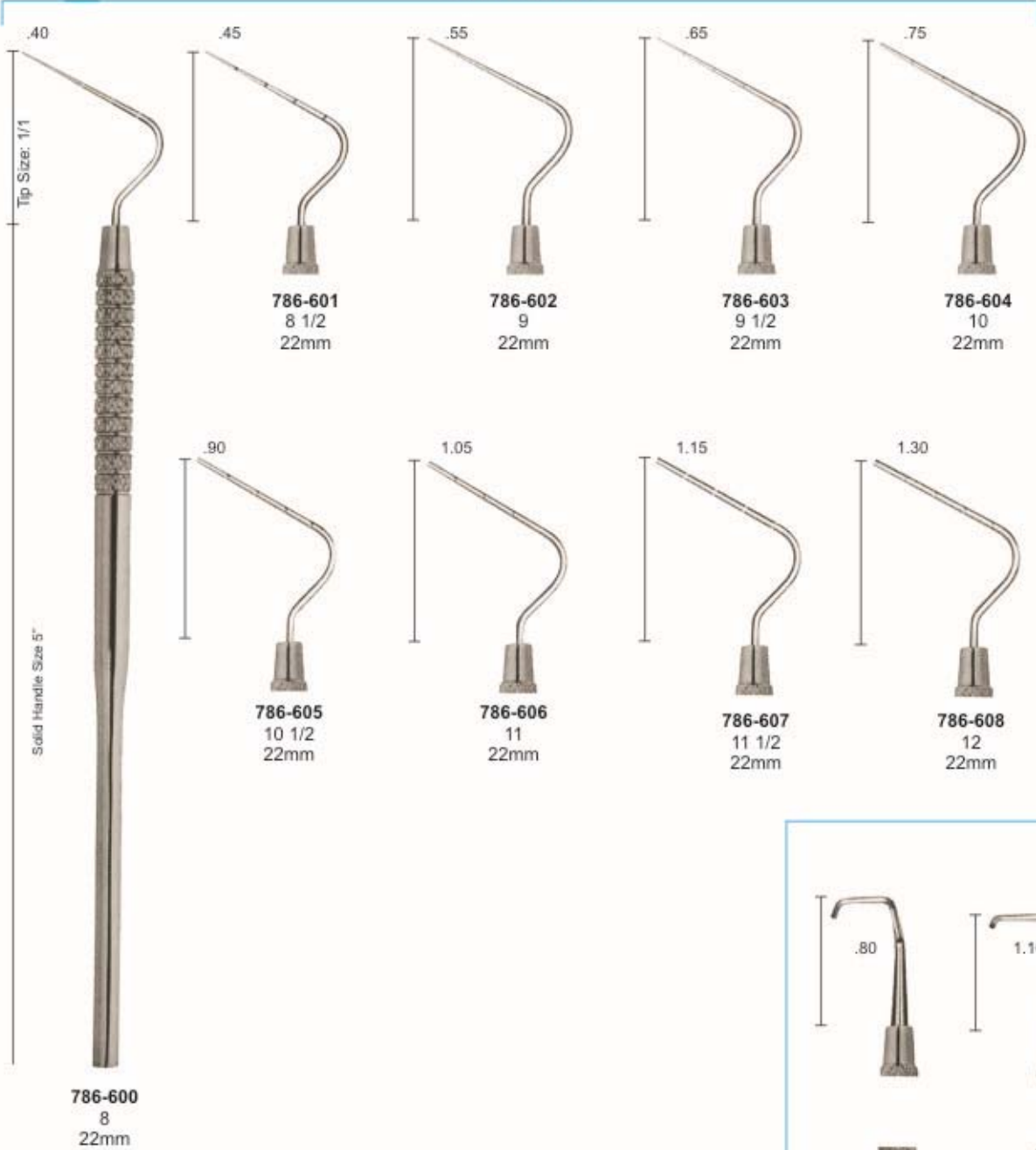

RETRO FILLING PLUGGERS

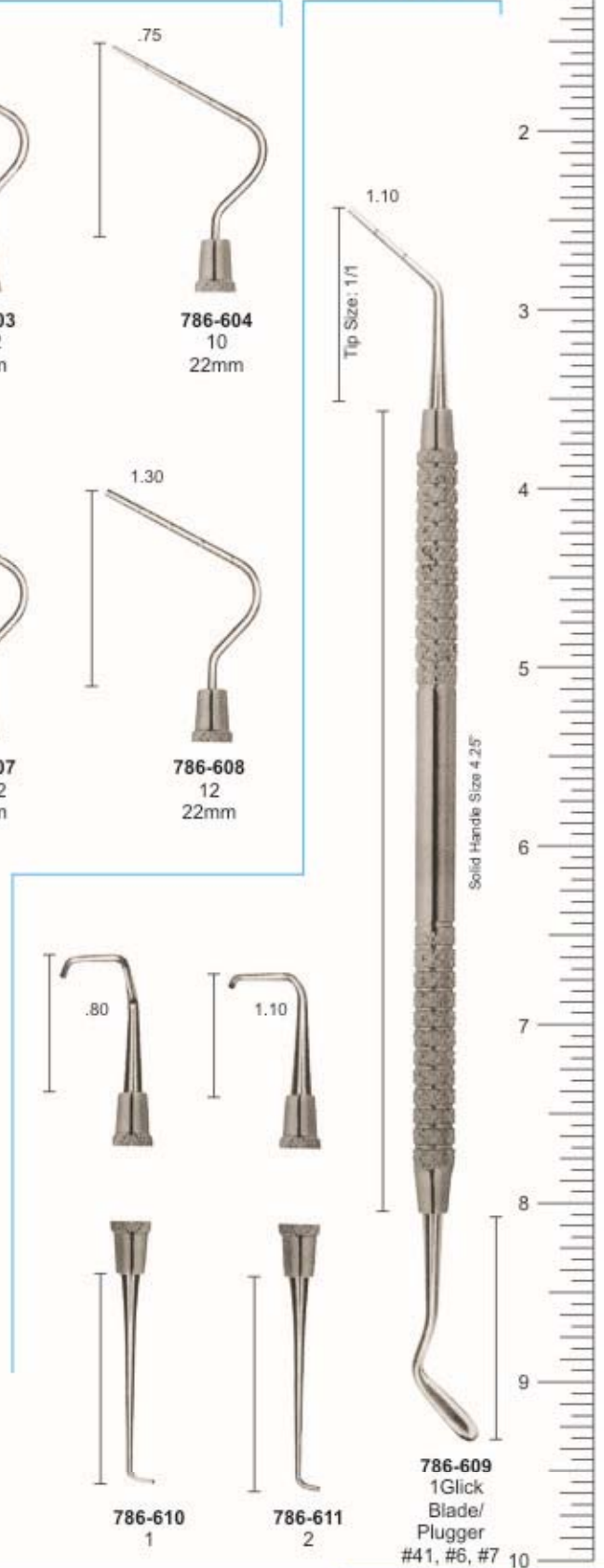

FILLING INSTRUMENTS

- Инструменты для реставрации
- Instruments pour plombage
- Füllungsinstrumente (mit Kontrawinkel)

- Инструменти для реставрації
- Instrumentos para obturaciones
- ملء الصكروك

COMPOSITE/PLASTIC FILLING INSTRUMENTS SOLID HANDLE 6MM, LENGTH 170MM

POSTERIOR

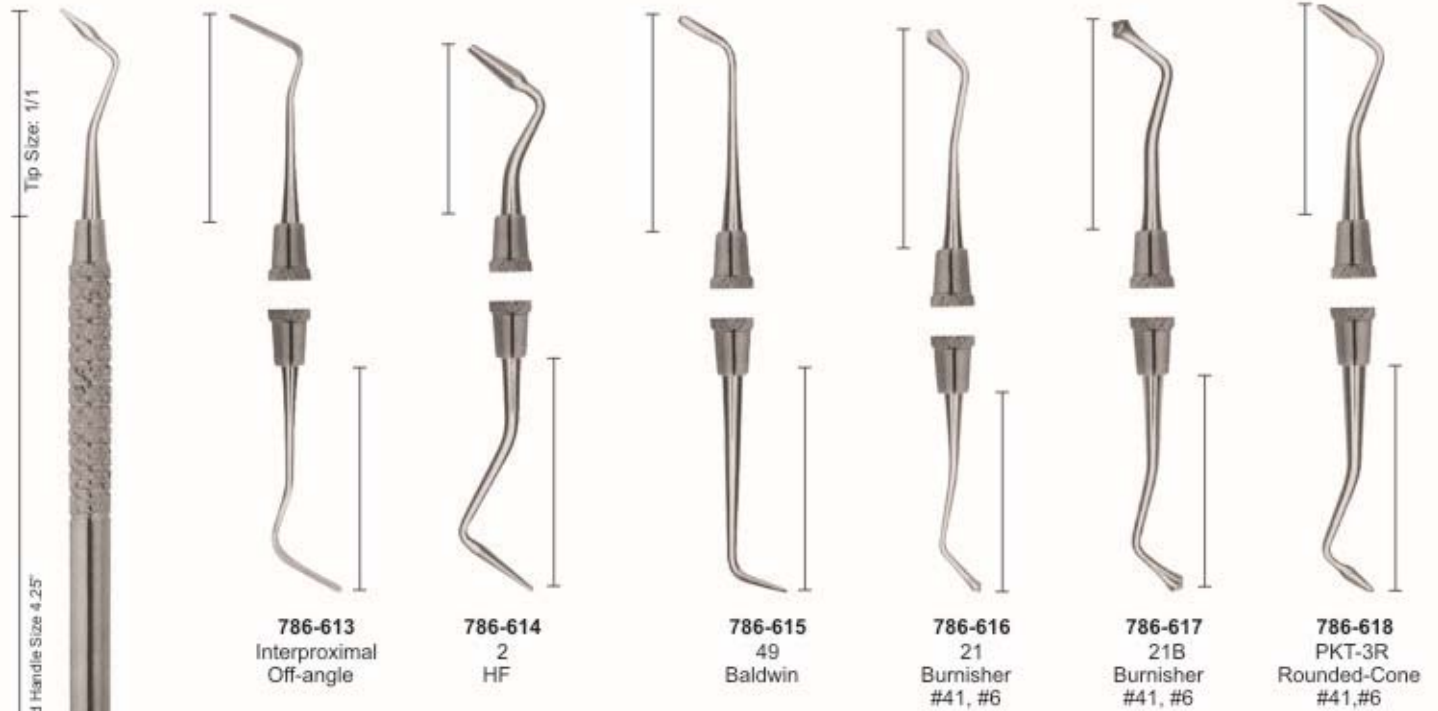

UNIVERSAL FILLING INSTRUMENTS

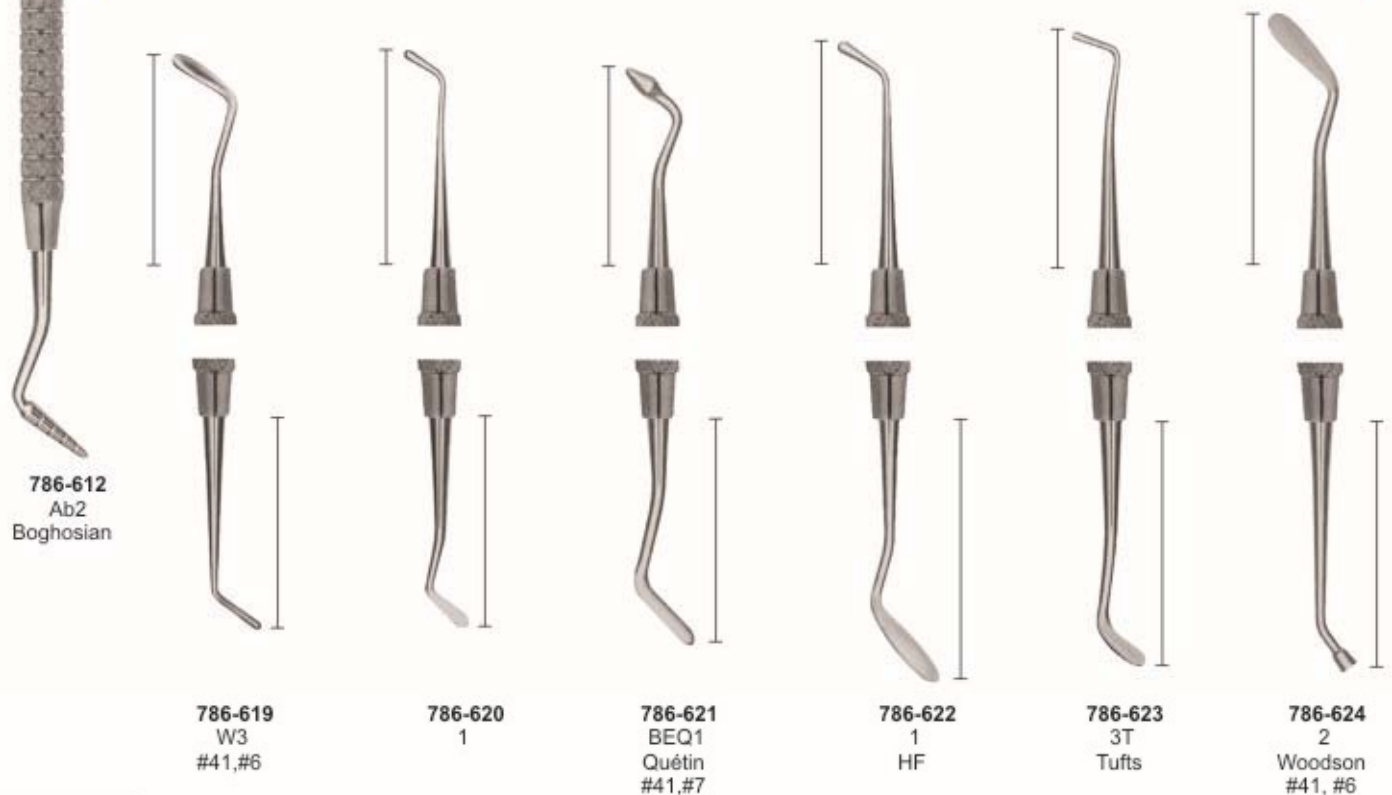

FILLING INSTRUMENTS

- Инструменты для реставрации
- Instruments pour plombage
- Füllungsinstrumente (mit Kontrawinkel)

- Інструменти для реставрації
- Instrumentos para obturaciones
- مل، الصكوك

COMPOSITE/PLASTIC FILLING INSTRUMENTS SOLID HANDLE 6MM, LENGTH 170MM

BLACK

PLUGGERS/CONDENSERS

Hollenback

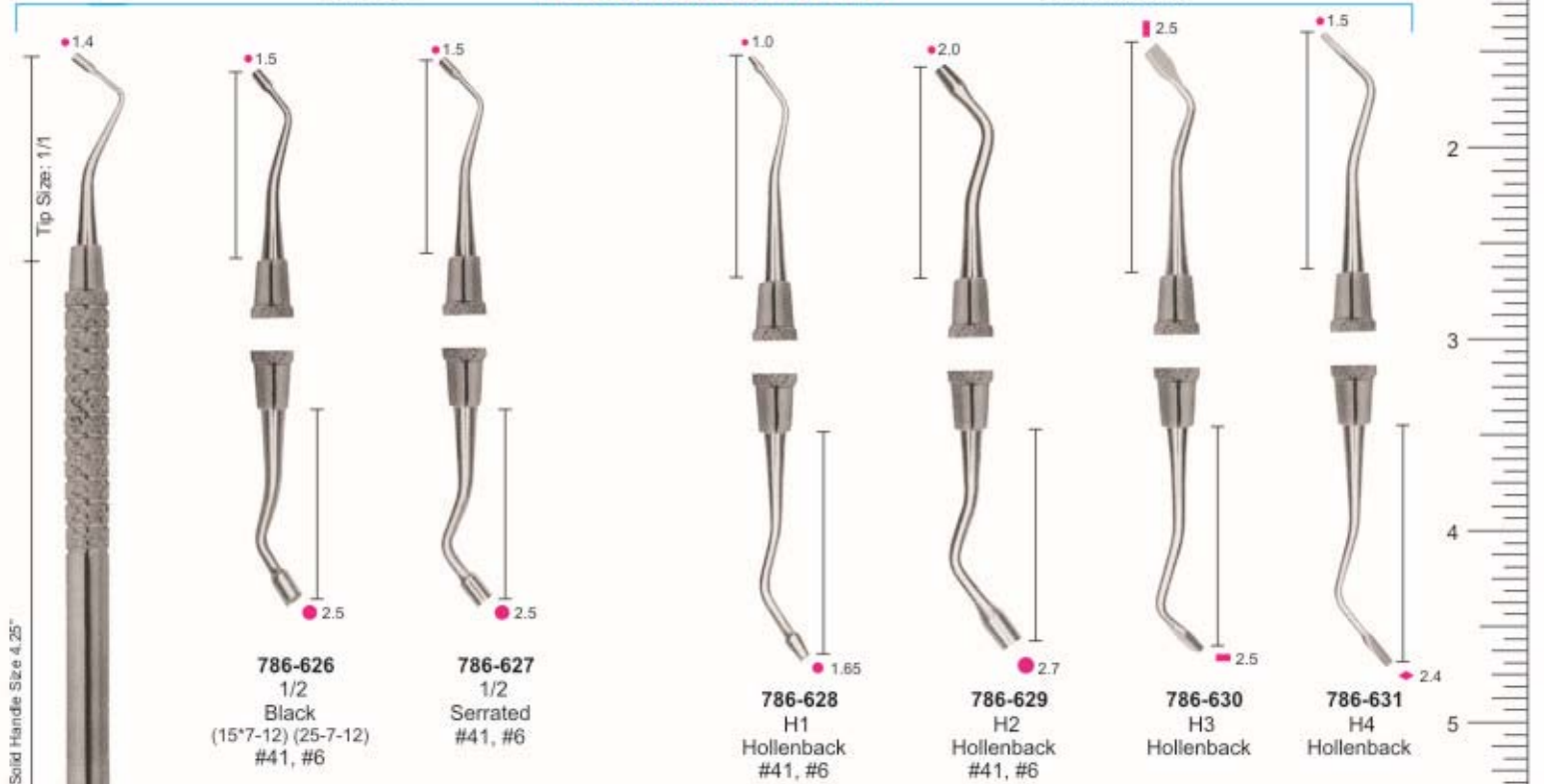

MARQUETTE CONDENSER

MORTONSON

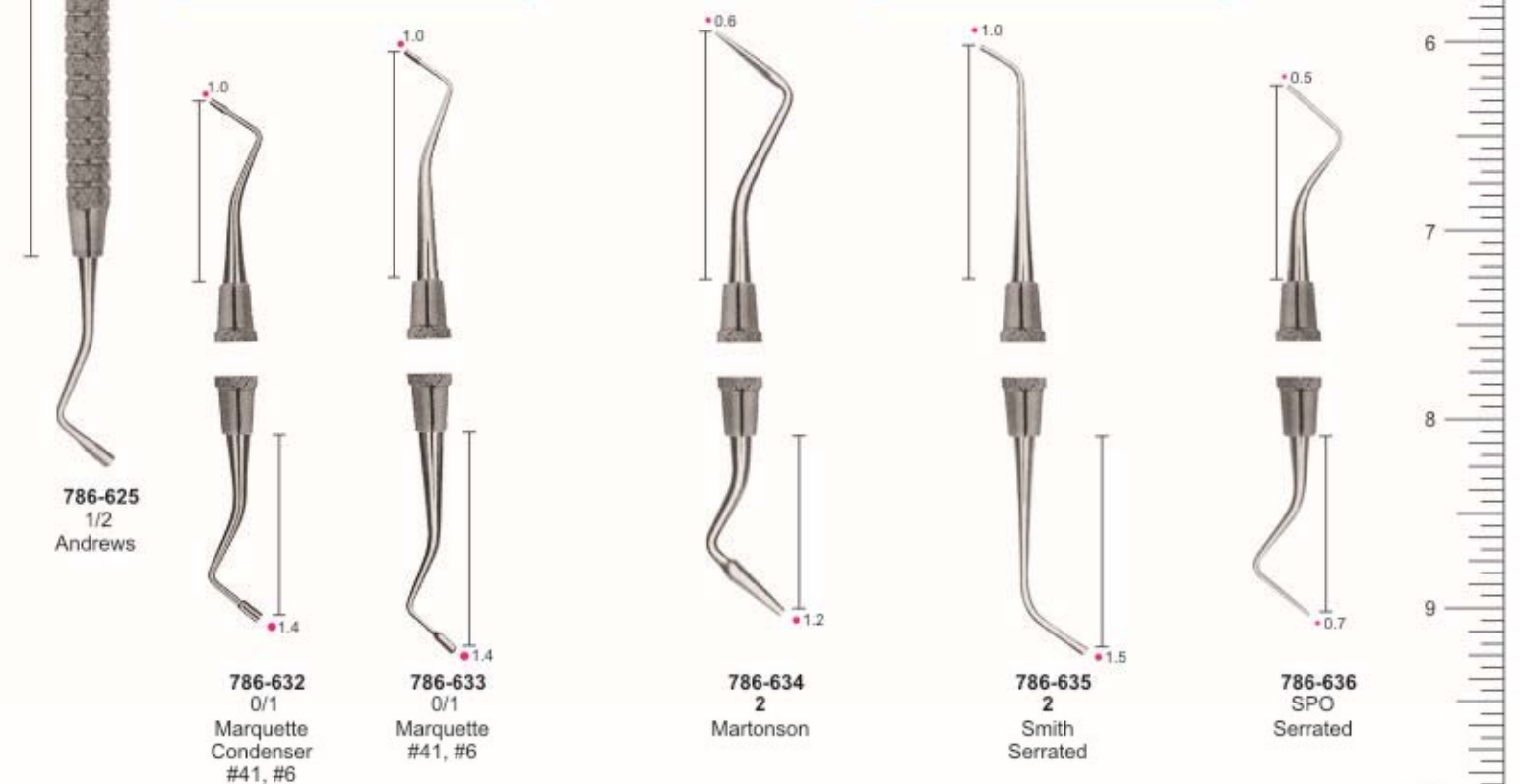

FILLING INSTRUMENTS

- Инструменты для реставрации
- Instruments pour plombage
- Füllungsinstrumente (mit Kontrawinkel)

- Инструменти для реставрації
- Instrumentos para obturaciones
- ملء المسكوك

PLUGGERS/CONDENSERS

RESTORATIVE INSTRUMENTS SOLID HANDLE 6MM, LENGTH 170MM

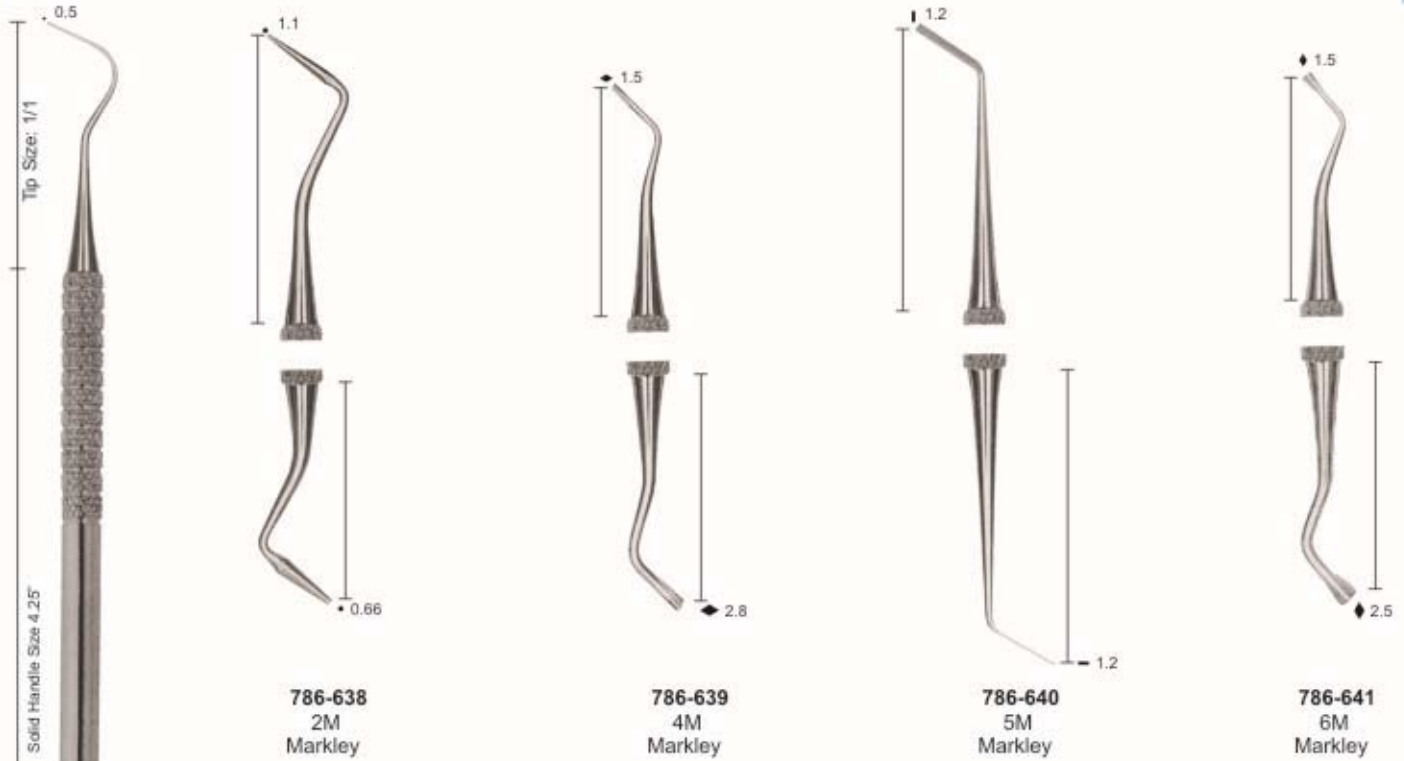

PLUGGERS/CONDENSERS

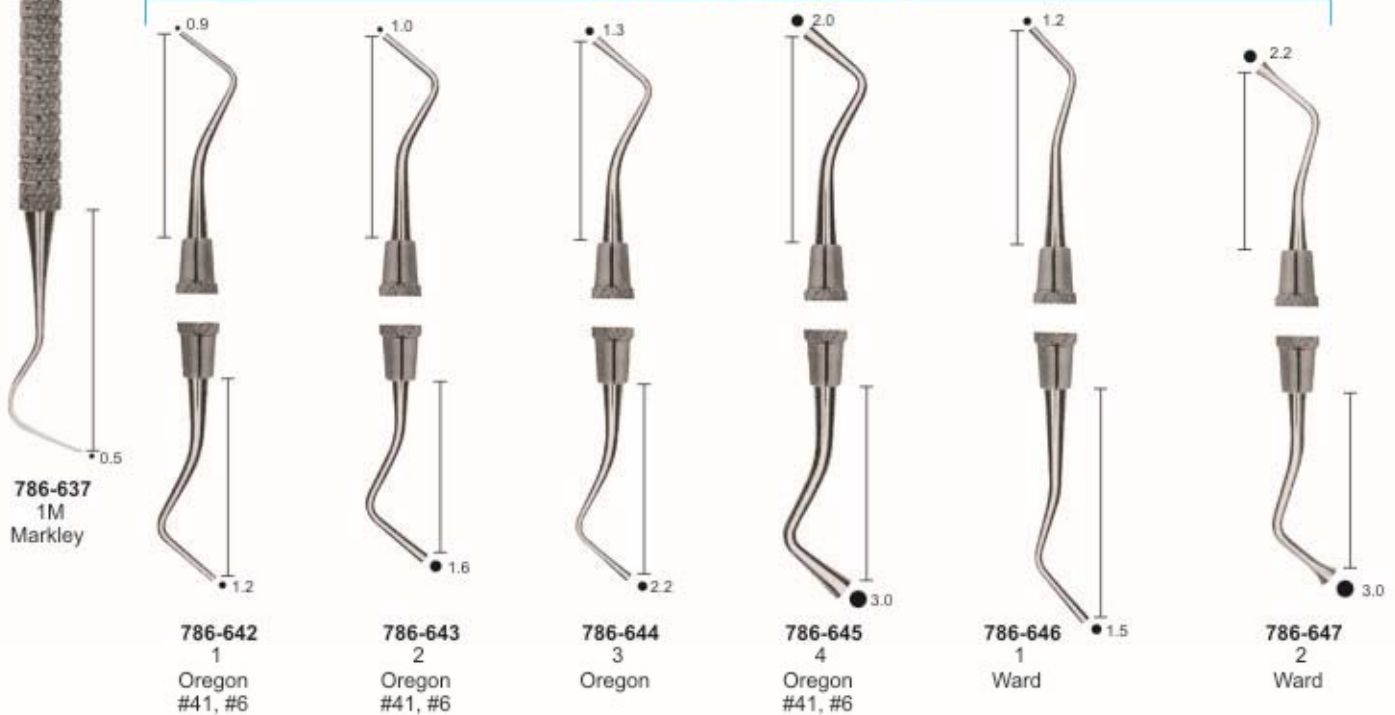

FILLING INSTRUMENTS

- Инструменты для реставрации
- Instruments pour plombage
- Füllungsinstrumente (mit Kontrawinkel)

- Інструменти для реставрації
- Instrumentos para obturaciones
- مل، الصكوك



TANNER FILLING INSTRUMENTS

RESTORATIVE INSTRUMENTS SOLID HANDLE 6MM, LENGTH 170MM

BACK ACTION FILLING INSTRUMENTS



Tip Size: 1/1



786-649
2T
Tanner

786-650
3T
Tanner



786-651
9/10
Back Action



786-652
11/12
Back Action



786-653
153
English Pattern Serrated



786-654
153
English Pattern Serrated

BURNISHERS

BALL

BEAVERTAIL

ACORN

LADMORE

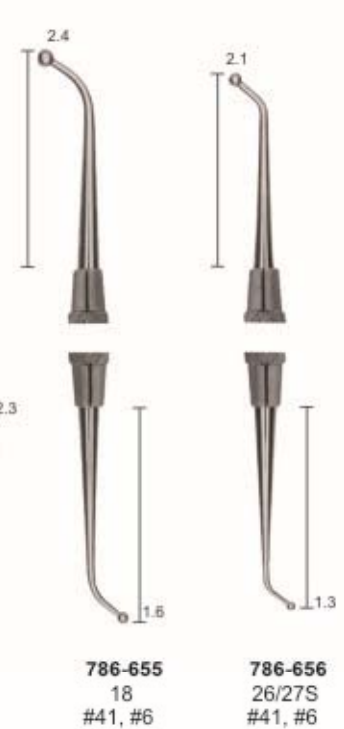

786-655
18
#41, #6

786-656
26/27S
#41, #6

786-657
27/29
#41, #6, #7, #8

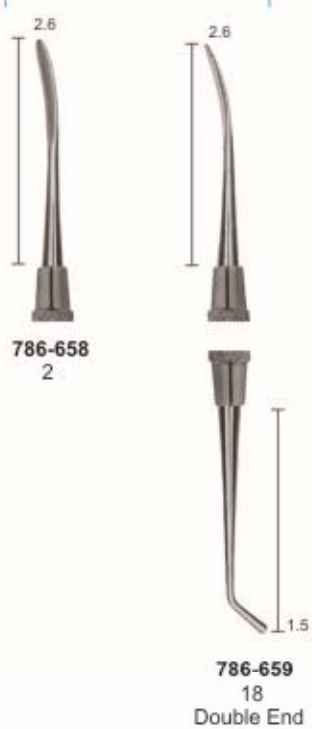

786-658
2

786-659
18
Double End



786-660
21
#41, #6

786-661
21B
#41, #6, #8



786-662
2
Ladmore

FILLING INSTRUMENTS

- Инструменты для реставрации
- Instruments pour plombage
- Füllungsinstrumente (mit Kontrawinkel)

- Инструменти для реставрації
- Instrumentos para obturaciones
- ملء الصكوك

RESTORATIVE INSTRUMENTS SOLID HANDLE 6MM, LENGTH 170MM

BURNISHERS

PERIODONTAL FILES

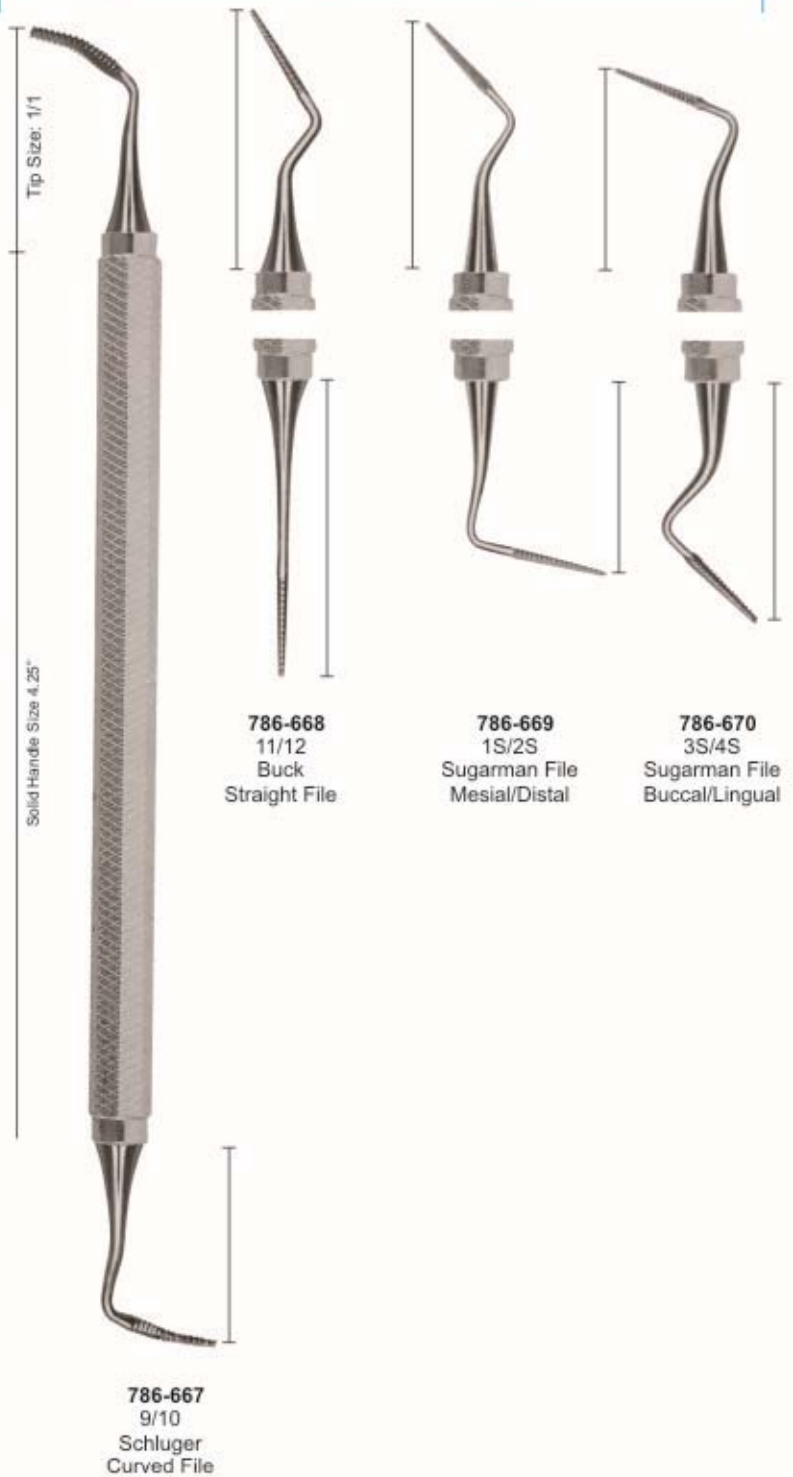
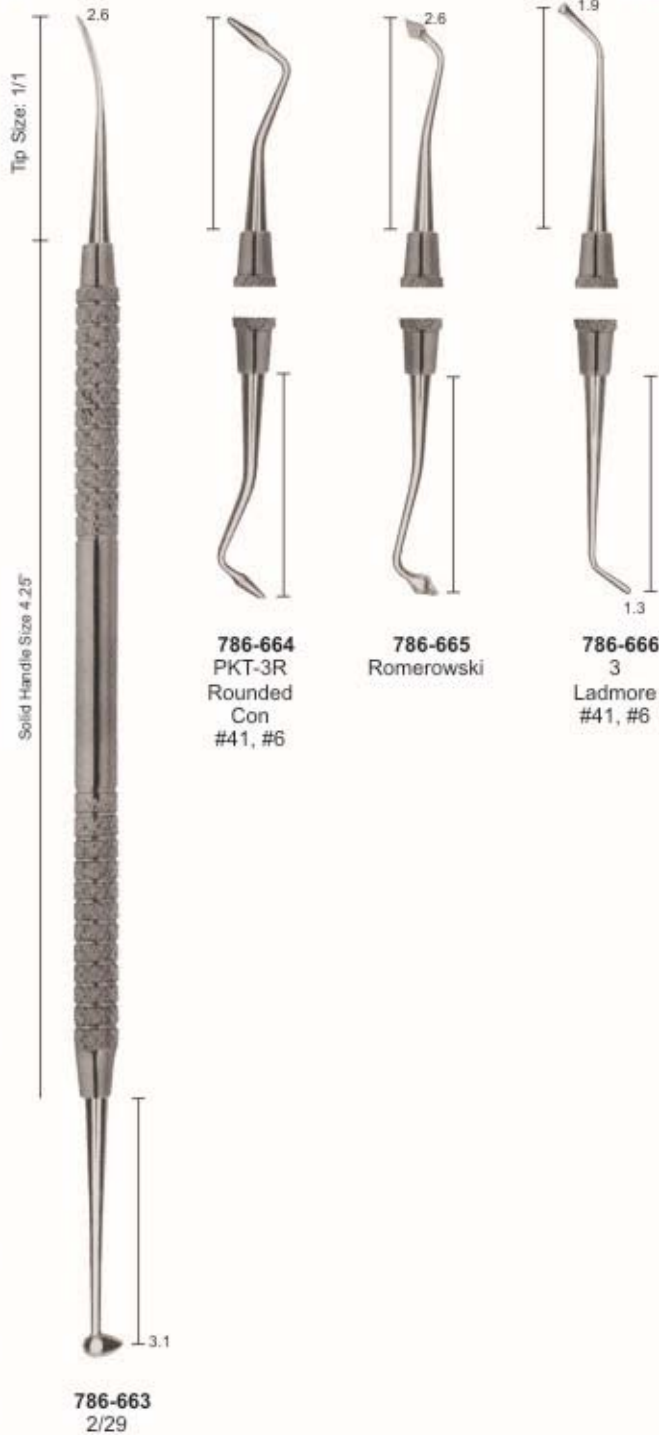

FILLING INSTRUMENTS

- Инструменты для реставрации
- Instruments pour plombage
- Füllungsinstrumente (mit Kontrawinkel)

- Інструменти для реставрації
- Instrumentos para obturaciones
- مل، الصكوك

BURNISHER FILLING INSTRUMENTS

COMPOSITE/PLASTIC FILLING INSTRUMENTS SOLID HANDLE 6MM, LENGTH 170MM

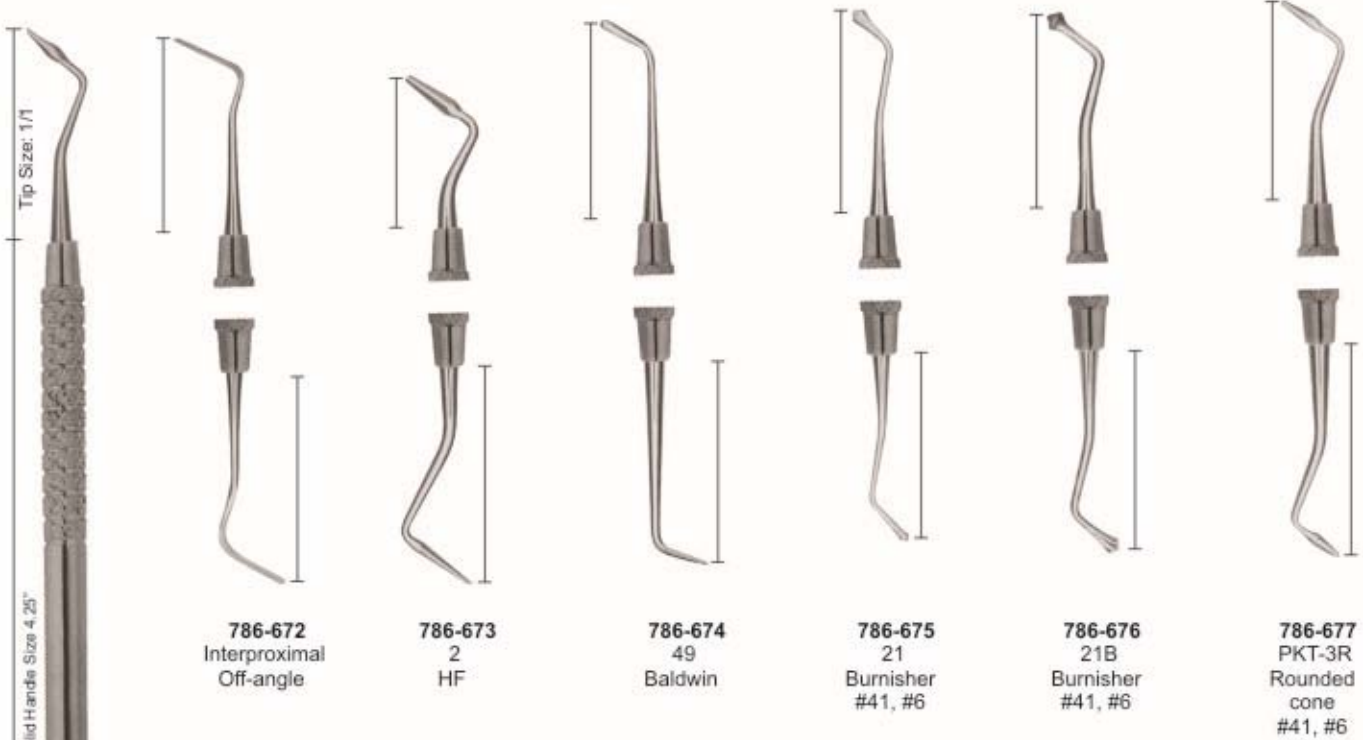

UNIVERSAL FILLING INSTRUMENTS

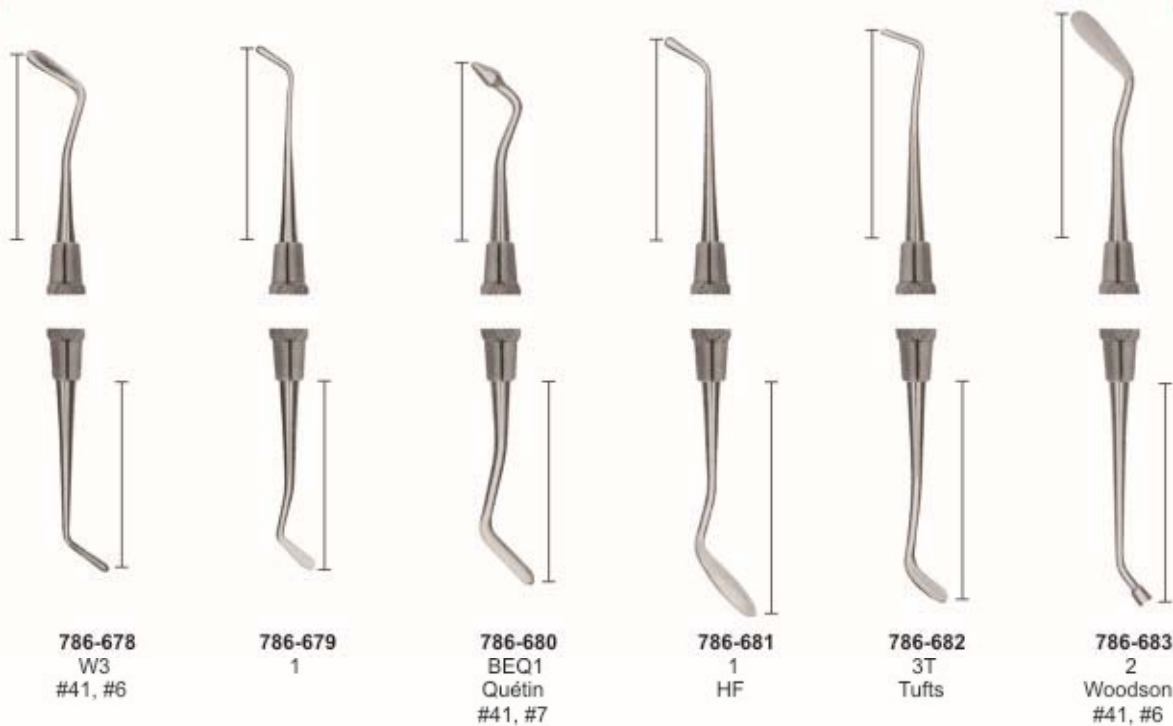

FILLING INSTRUMENTS

- Инструменты для реставрации
- Instruments pour plombage
- Füllungsinstrumente (mit Kontrawinkel)

- Инструменты для реставрації
- Instrumentos para obturaciones
- ملء الصكوك

FILLING INSTRUMENTS SOLID HANDLE 6MM, LENGTH 170MM

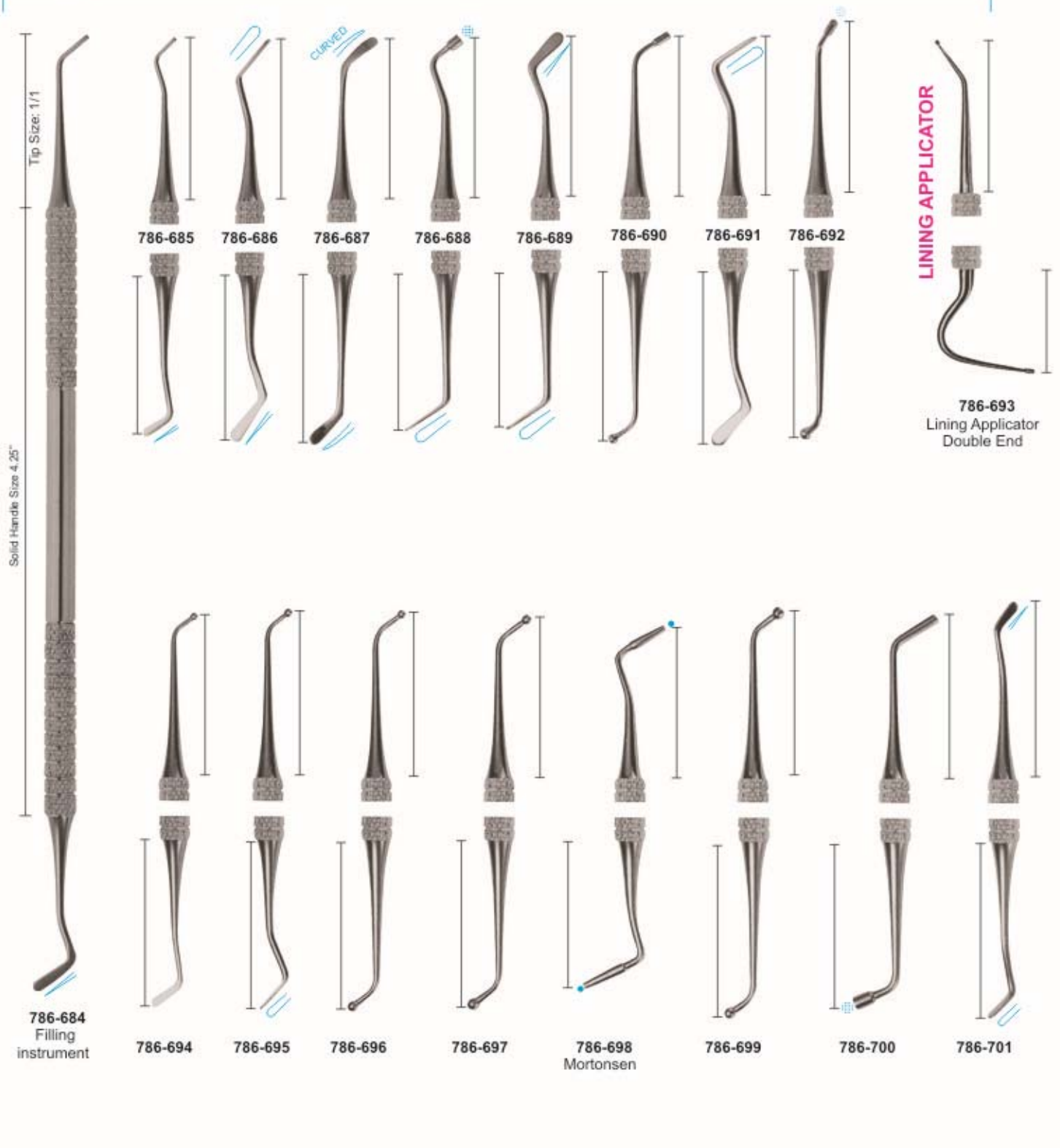

AMALGAM CARVERS

- Инструменты для реставрации
- Instruments pour amalgame
- Amalgampistolen

- Инструменти для реставрації
- Instrumentos para amalgama
- لتطيق السلفيم

AMALGAM INSTRUMENTS SOLID HANDLE 6MM, LENGTH 170MM

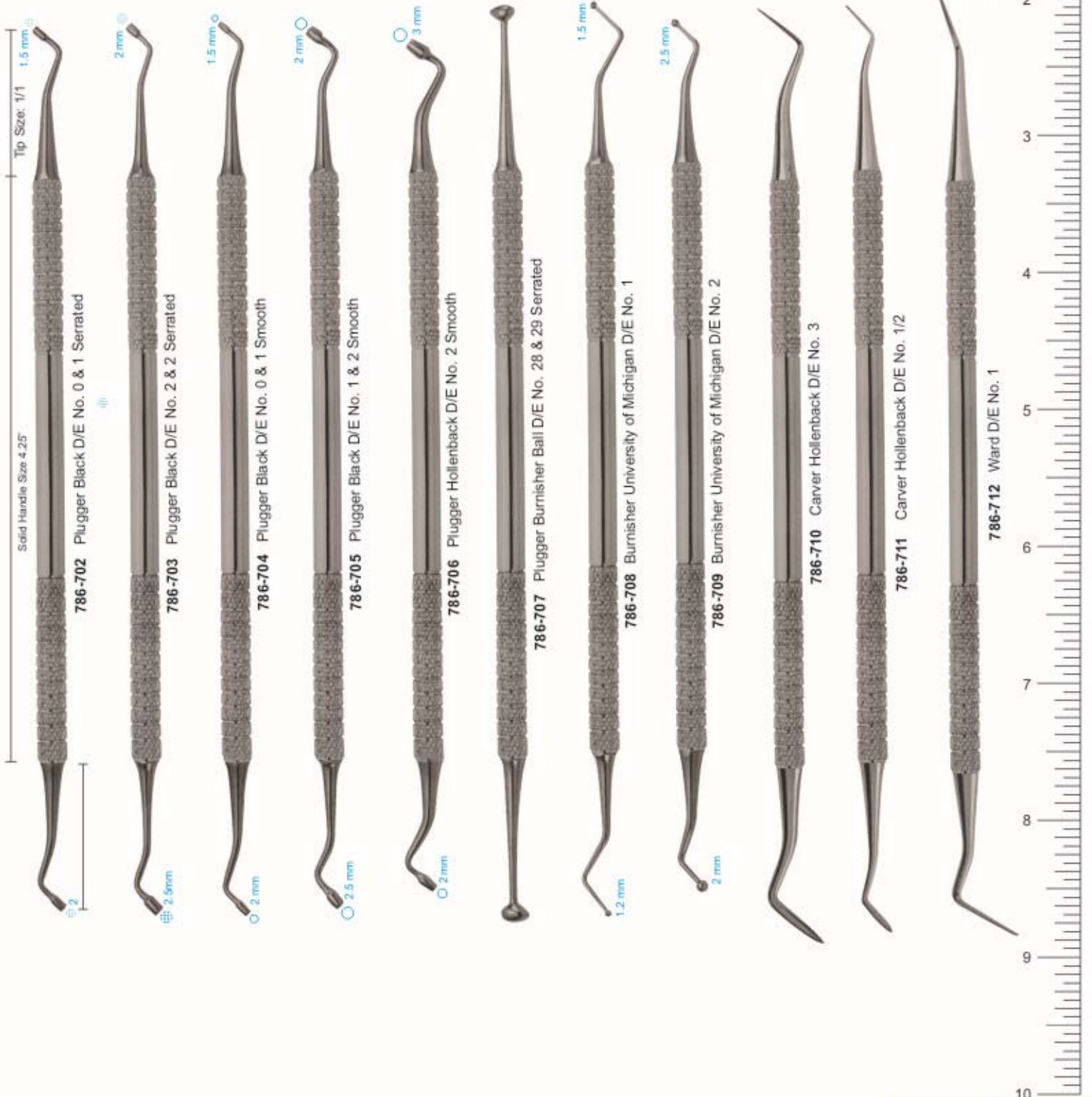

AMALGAM CARVERS

■ Инструменты для реставрации
 ■ Instruments pour amalgame
 ■ Amalgampistolen

■ Инструменты для реставрації
 ■ Instrumentos para amalgama
 ■ تطعيع السلفم

AMALGAM INSTRUMENTS SOLID HANDLE 6MM, LENGTH 170MM

Excavators Instruments Set of 11 Pieces

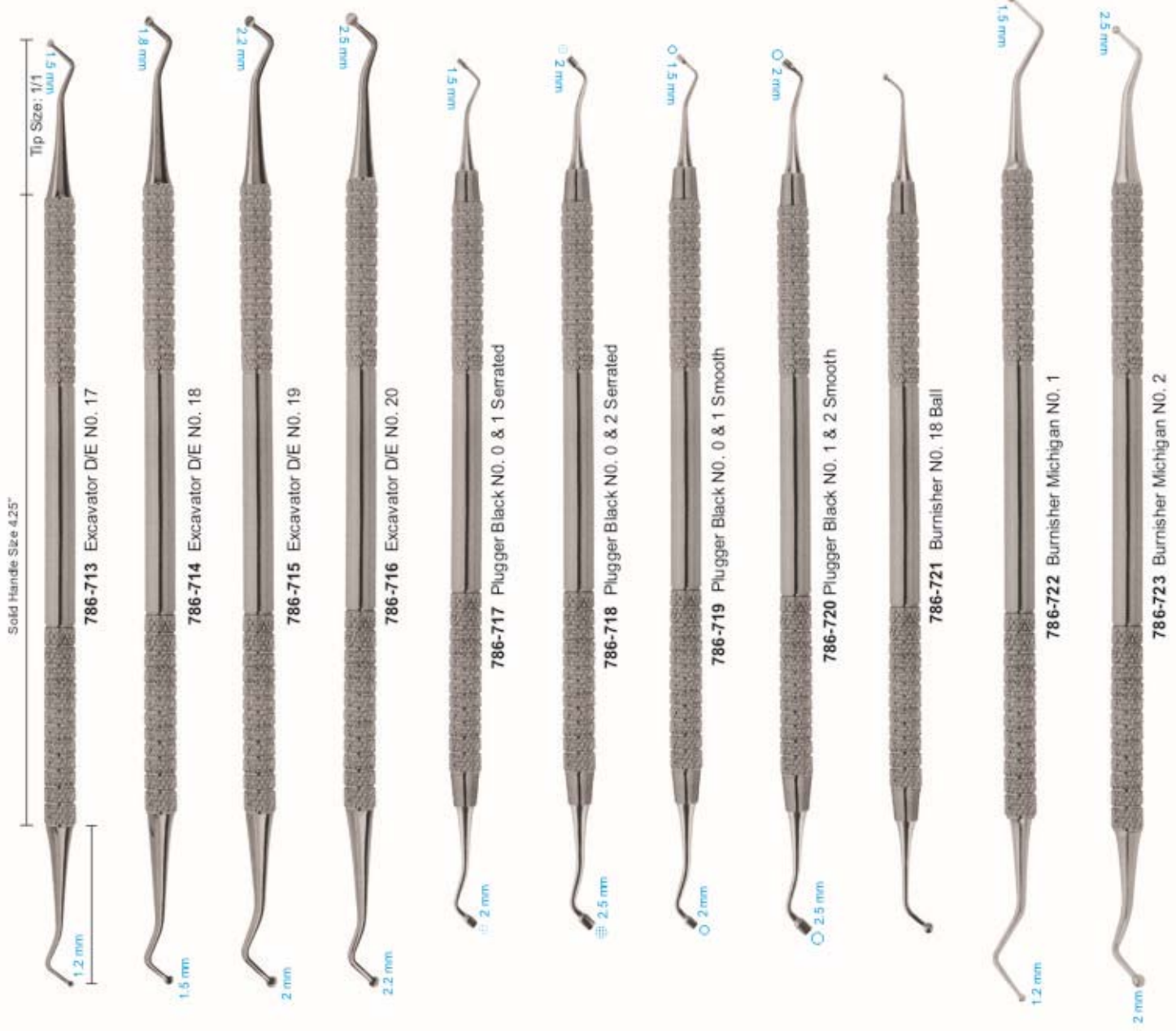

786-713 Excavator D/E NO. 17

PERIODONTAL INSTRUMENTS

■ Инструменты пародонтологические
 ■ Instruments pour la parodontologie
 ■ Instrumente für die Parodontologie

■ Інструменти пародонтологічні
 ■ Instrumentos para periodoncia
 ■ الصكر ك اللثة

SICKLE SCALERS INSTRUMENTS SOLID HANDLE 6MM, LENGTH 170MM

SICKLE SCALERS



786-724
 H6/H7 T
 #2, #4, #6,
 #7, #8, #9

786-725
 6/7
 Goldman
 #2, #4, #6,
 #7, #8

786-726
 U15
 Towner
 #24, #6,
 #7, #8

786-727
 H15/U15
 Hygienist-
 Towner
 #2, #4, #6

786-728
 U15/30
 Towner-
 Jacquette
 #2, #4, #6,
 #7, #8, #9

786-729
 H15/33 T
 Hygienist-
 Jacquette
 #2, #4, #6,
 #7, #8, #9

786-730
 U15/33
 Towner-
 Jacquette
 #2, #4, #6,
 #7, #8, #9

PERIODONTAL INSTRUMENTS

■ Инструменты пародонтологические
 ■ Instruments pour la parodontologie
 ■ Instrumente für die Parodontologie

■ Інструменти пародонтологічні
 ■ Instrumentos para periodoncia
 ■ الصكوك اللثة

PERIODONTAL INSTRUMENTS SOLID HANDLE 6MM, LENGTH 170MM

JACQUETTE SCALERS

CRANE KAPLAN



786-731
 30/33
 Hygienist
 Jacquette
 #2, #4, #6,
 #7, #8, #9

786-732
 31/32
 Jacquette
 #2, #4, #6,
 #7, #8, #9

786-733
 34/38
 Jacquette
 #2, #4, #6,
 #7, #8, #9

786-734
 H3/H4
 Jacquette
 #2, #4, #6,

786-735
 30/33
 Posterior
 Jacquette
 #2, #4, #6,

786-736
 CK-6
 #2, #4, #6,

PERIODONTAL INSTRUMENTS

■ Инструменты пародонтологические
 ■ Instruments pour la parodontologie
 ■ Instrumente für die Parodontologie

■ Інструменти пародонтологічні
 ■ Instrumentos para periodoncia
 ■ الصكوك اللثة

PERIODONTAL INSTRUMENTS SOLID HANDLE 6MM, LENGTH 170MM

SCALER/CURETTE SETS

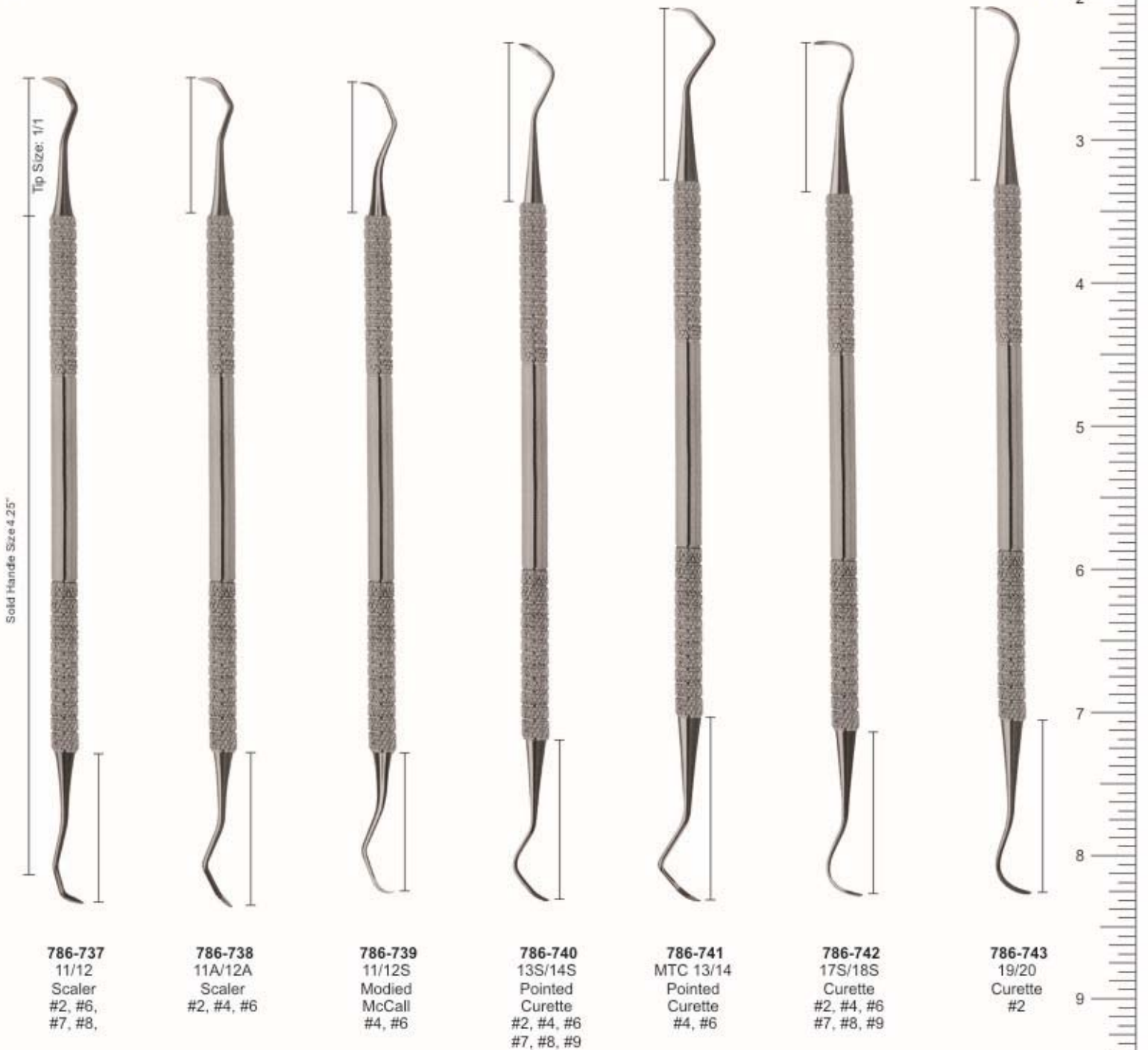

786-737
 11/12
 Scaler
 #2, #6,
 #7, #8,

786-738
 11A/12A
 Scaler
 #2, #4, #6

786-739
 11/12S
 Modief
 McCall
 #4, #6

786-740
 13S/14S
 Pointed
 Curette
 #2, #4, #6
 #7, #8, #9

786-741
 MTC 13/14
 Pointed
 Curette
 #4, #6

786-742
 17S/18S
 Curette
 #2, #4, #6
 #7, #8, #9

786-743
 19/20
 Curette
 #2



CURETTES

- Кюрети
 - Curetas
 - Küretten
- Кюрети
 - Curette
 - کرتس

SCALER/CURETTE SETS

GOLDMAN-FOX SET

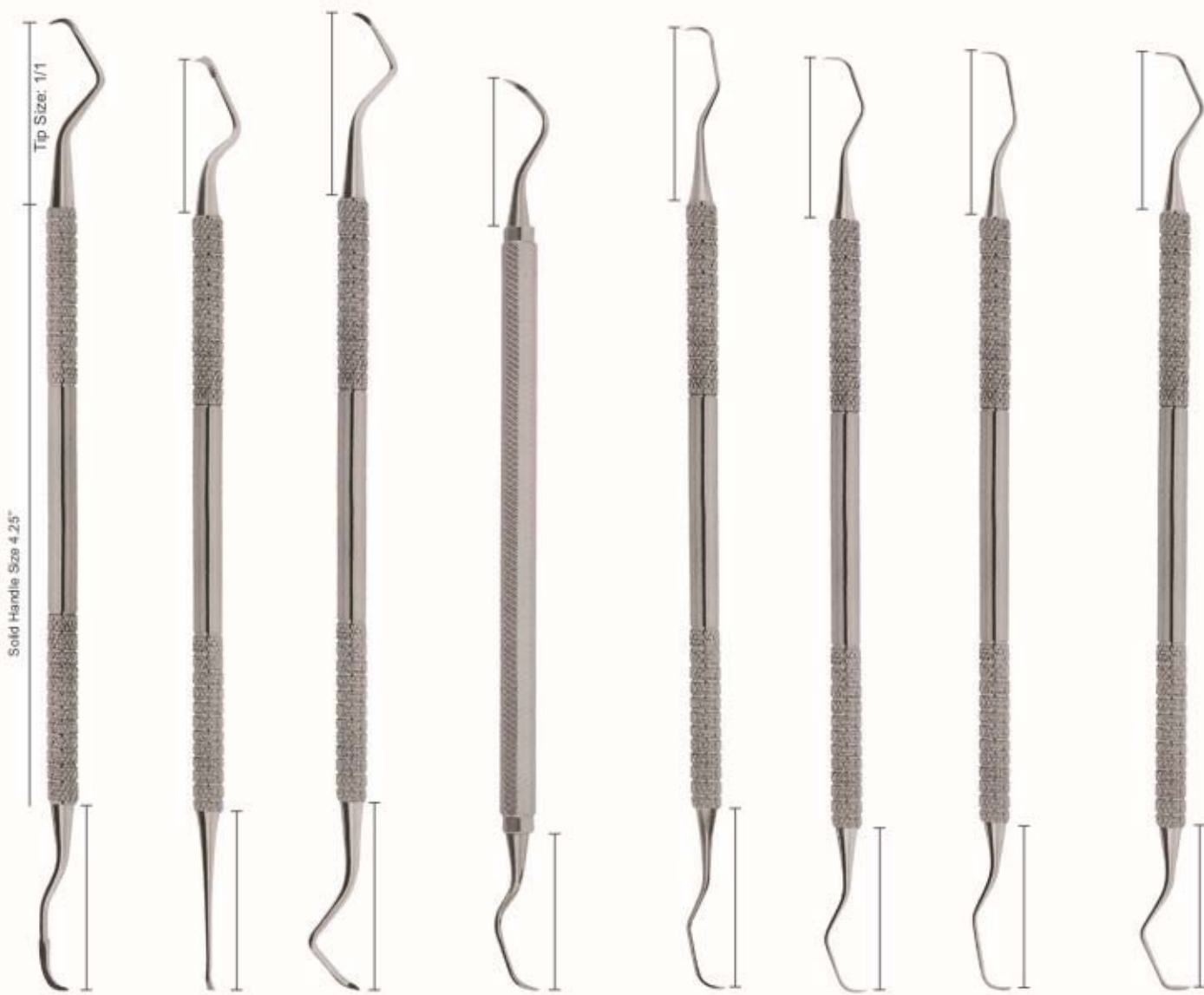

786-744
103/106
#4, #6

786-744A
104/106
Hoe/Chisel
#4, #6,

786-745
107/108
#2, #4, #6
#7, #8

786-746
107/108S
Modied
#2, #4

786-747
1/2
(shown)
#2, #4, #6
#7, #8, #9

786-749
3/4T
(shown)
#2, #4, #6
#7, #8, #9

786-751
5/6T
(shown)
#2, #4, #6
#7, #8, #9

786-754
7/8T
(shown)
#2, #4, #6
#7, #8, #9

786-748
1/2
Rigid
#2, #4, #6
#7, #8, #9

786-750
3/4
Rigid
#2, #4, #6
#7, #8, #9

786-752
5/6
Rigid
#2, #4, #6
#7, #8, #9

786-753
5/6
Extra Rigid
#4, #6 #7
#8

786-755
7/8
Rigid
#2, #4, #6
#7, #8, #9

786-756
7/8
Extra Rigid
#2, #4, #6
#7, #8, #9

**SCALER/CURETTE SETS INSTRUMENTS
SOLID HANDLE 6MM, LENGTH 170MM**

CURETTES

- Кюрети
- Curetas
- Küretten
- Кюрети
- Curette
- كرتس

GRACEY CURETTE INSTRUMENTS SOLID HANDLE 6MM, LENGTH 170MM
GRACEY CURETTES

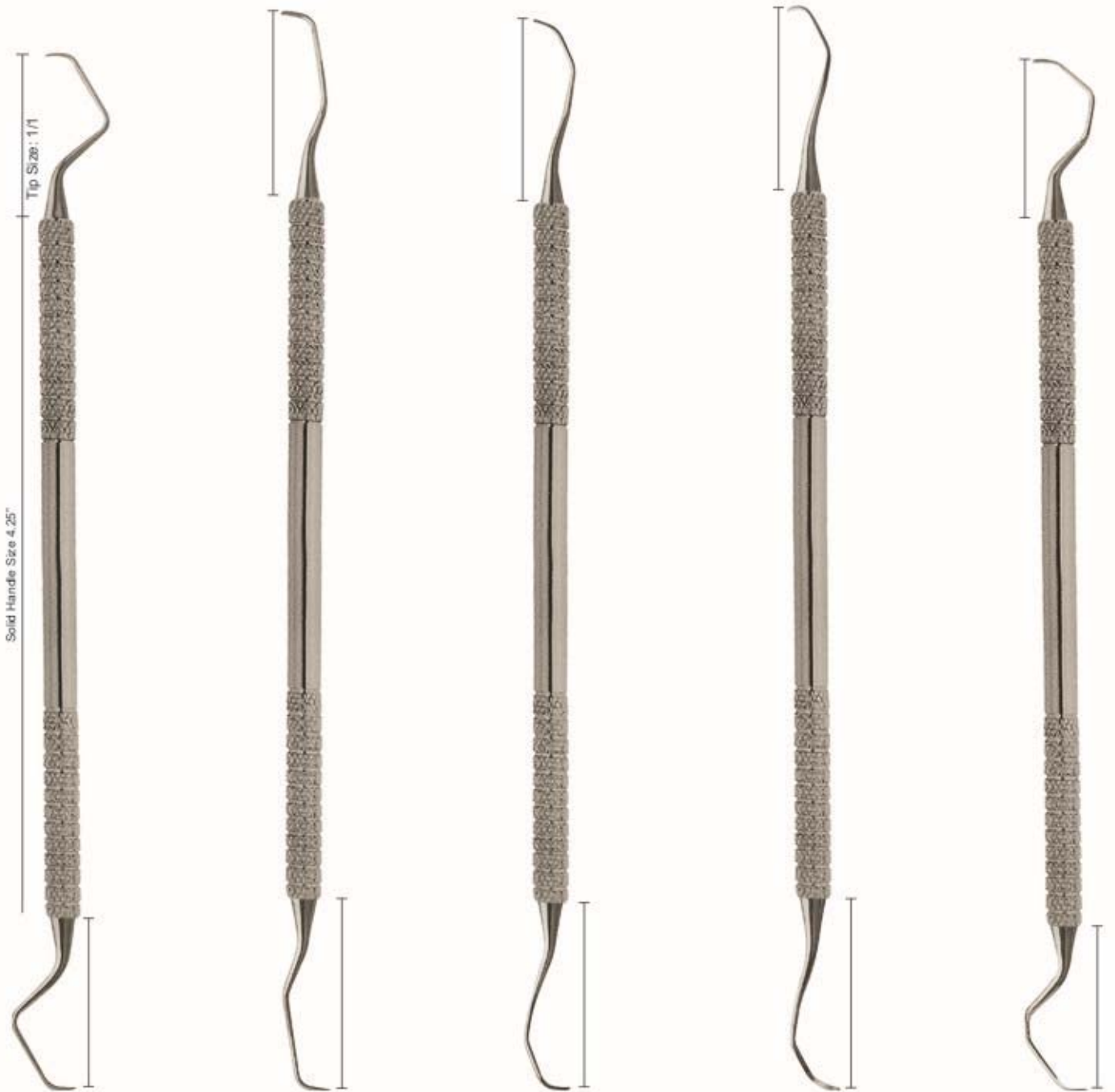

786-757
9/10T
(shown)
#2, #4, #6
#7, #8, #9

786-759
11/12T
(shown)
#2, #4, #6
#7, #8, #9

786-792
13/14T
(shown)
#2, #4, #6
#7, #8, #9

786-765
15/16T
(shown)
#2, #4, #6
#7, #8, #9

786-767
17/18
(shown)
#2, #4, #6
#7, #8, #9

786-758
9/10
Rigid
#2, #4, #6
#7, #8, #9

786-760
11/12
Rigid
#2, #4, #6
#7, #8, #9

786-761
11/12
Extra Rigid
#4, #6
#7, #8

786-793
13/14
Rigid
#2, #4, #6
#7, #8, #9

786-764
13/14
Extra Rigid
#4, #6
#7, #8

786-766
15/16
Rigid
#2, #4, #6
#7, #8, #9

786-768
17/18
Rigid
#2, #4, #6
#7, #8, #9

CURETTES

■ Кюрети
■ Curetas
■ Küretten

■ Кюрети
■ Curette
■ کرتس

CURETTE INSTRUMENTS
HOLLOW HANDLE 8.5MM, LENGTH 170MM

CURETTE INSTRUMENTS
SOLID HANDLE 6MM, LENGTH 170MM

CURETTE INSTRUMENTS
SOLID HANDLE 6MM, LENGTH 170MM

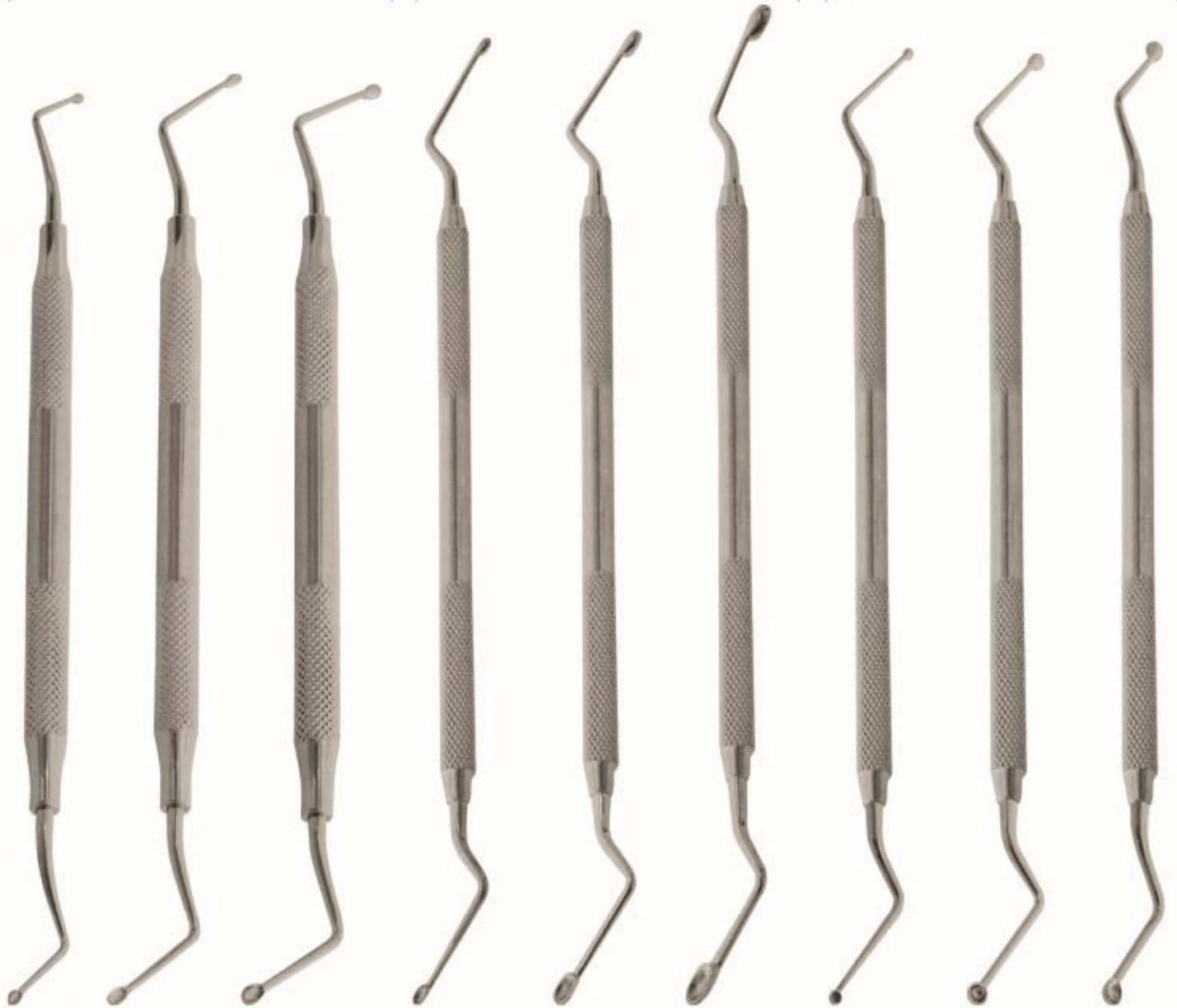

786-769
Hemingway
2mm, 2mm

786-770
Hemingway
3mm, 3mm

786-771
Hemingway
4mm, 4mm

786-772
Hemingway
2mm, 2mm

786-773
Hemingway
3mm, 3mm

786-774
Hemingway
4mm, 4mm

786-785
Hemingway
2mm, 2mm

786-776
Hemingway
3mm, 3mm

786-777
Hemingway
4mm, 4mm

EXCAVATORS

■ Экскаваторы
■ Excavateurs
■ Excavatoren

■ Excavatori
■ Excavadores
■ حفارات

EXCAVATOR INSTRUMENTS SOLID HANDLE 6MM, LENGTH 170MM

SPOONS

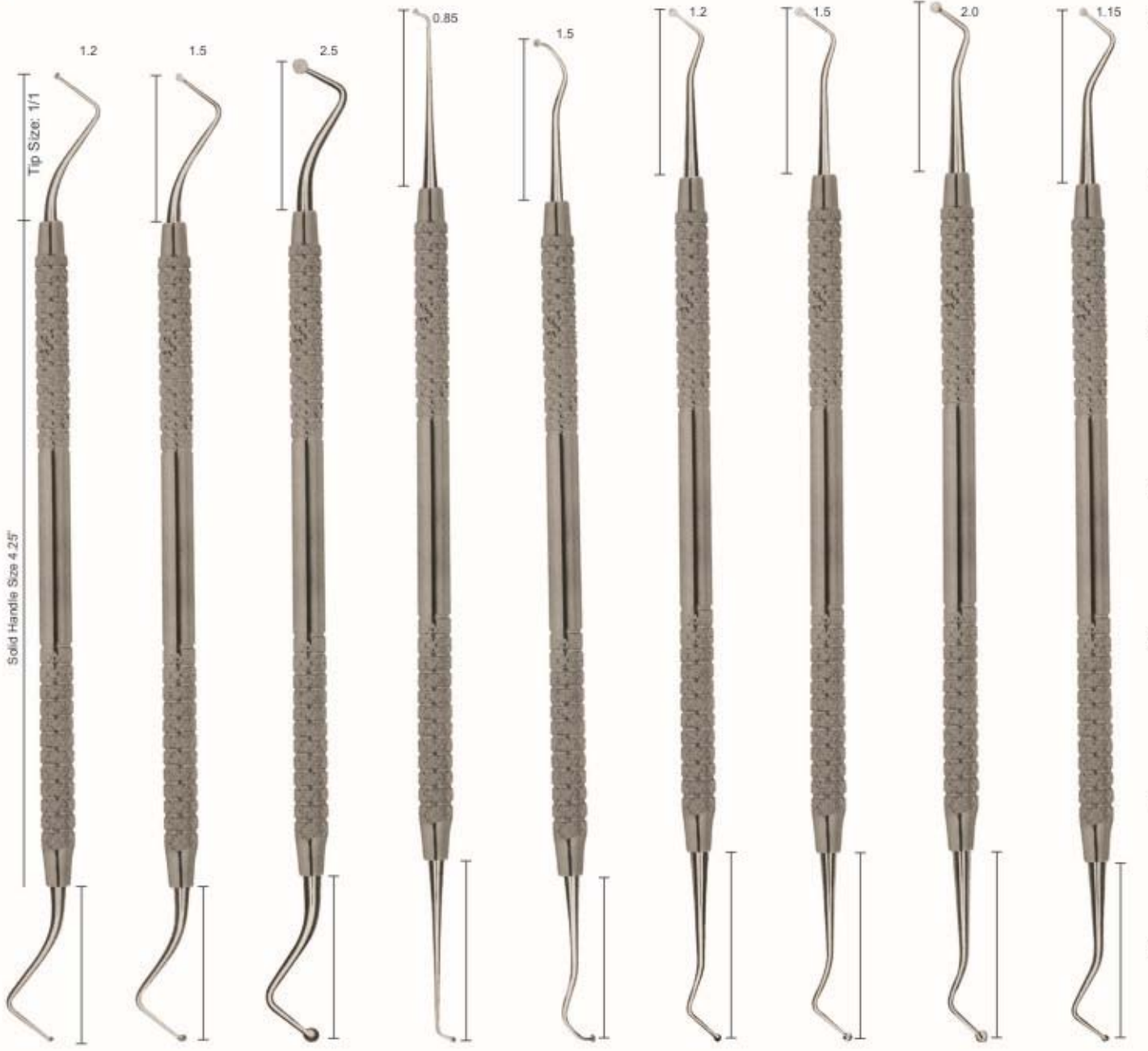

786-778
E1
(12-9-15)
#41, #6

786-779
E2
(12-9-15)
#41, #6

786-780
E3
(12-9-15)

786-781
6

786-782
14

786-783
17
#41, #6
#7, #8

786-784
18
#41, #6
#7, #8

786-785
19
#41, #6
#7, #8

786-786
38/39
(11.5-7-14)
#41, #6, #7



EXCAVATORS

■ Экскаваторы
■ Excavateurs
■ Excavatoren

■ عسكافاطوري
■ Excavadores
■ حفارات

OVAL SPOONS/DARBY-PERRY

EXCAVATORS INSTRUMENTS
SOLID HANDLE 6MM, LENGTH 170MM

EXCAVATORS

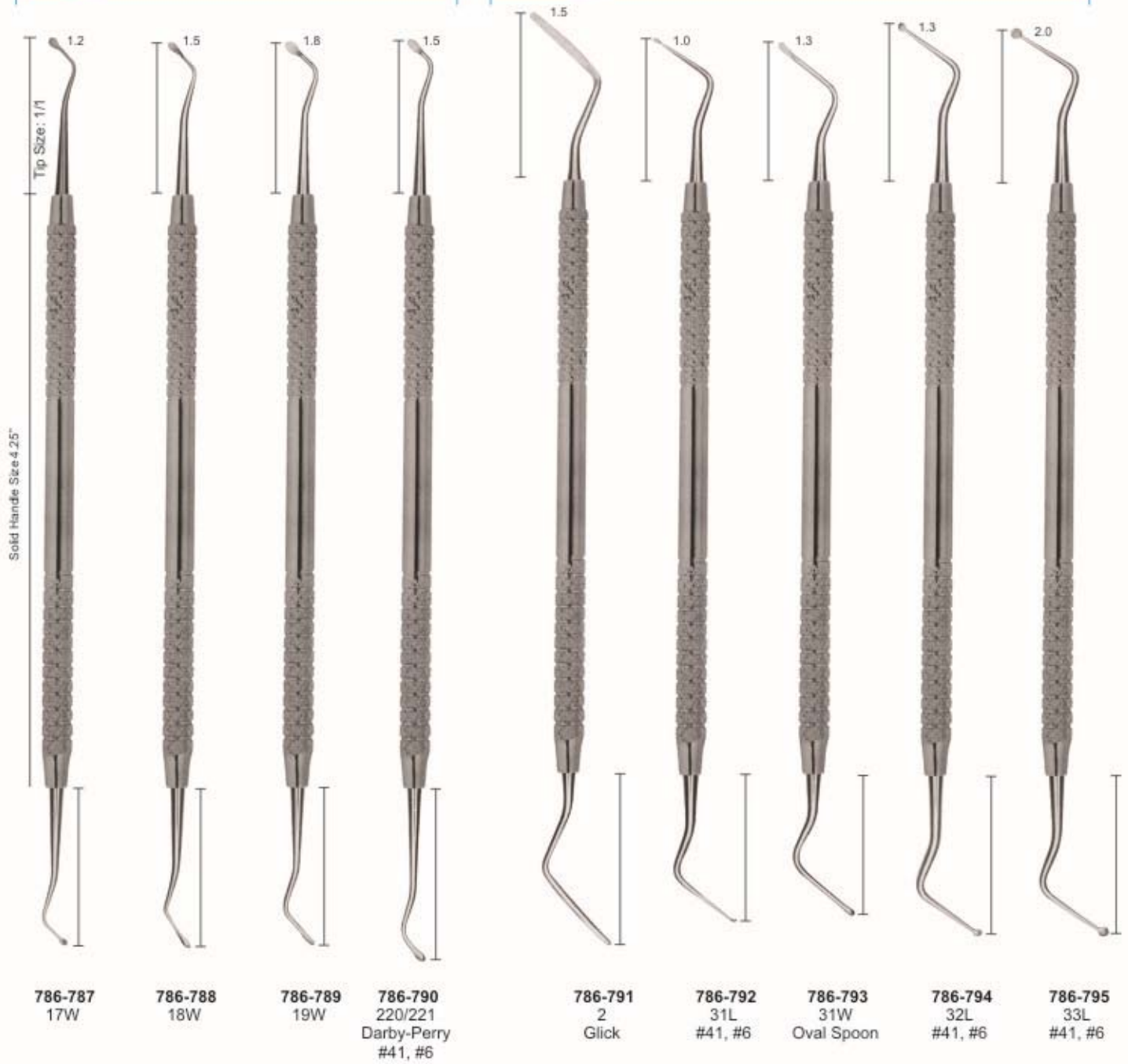

EXCAVATORS

■ Экскаваторы
■ Excavateurs
■ Excavatoren

■ Excavatori
■ Excavadores
■ حفارات

EXCAVATOR INSTRUMENTS SOLID HANDLE 6MM, LENGTH 170MM

BLADES

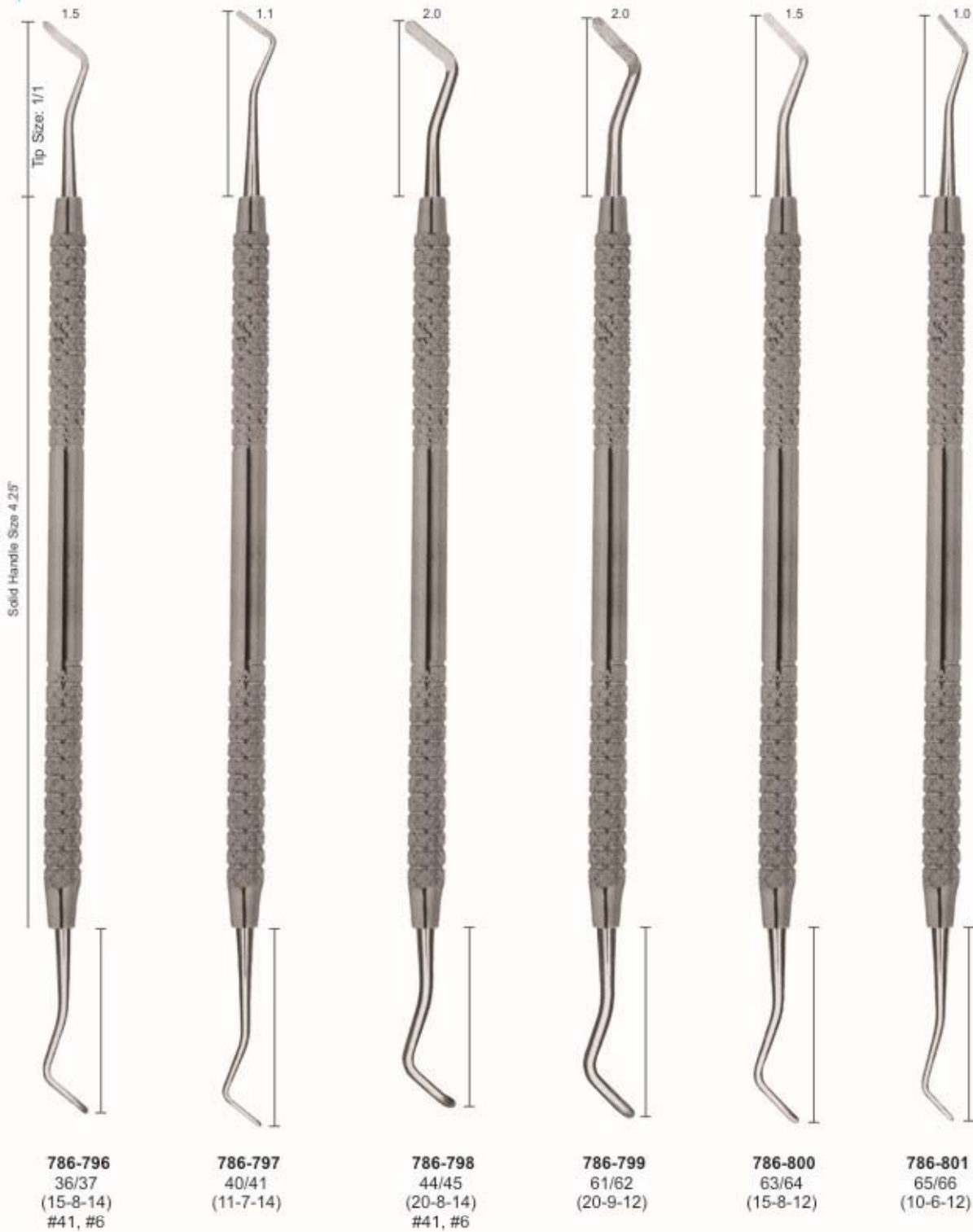

EXCAVATORS

■ Экскаваторы
■ Excavateurs
■ Excavatoren

■ Экскаватори
■ Excavadores
■ حطارات

EXCAVATORS INSTRUMENTS SOLID HANDLE 6MM, LENGTH 170MM

ENGLISH PATTERNS

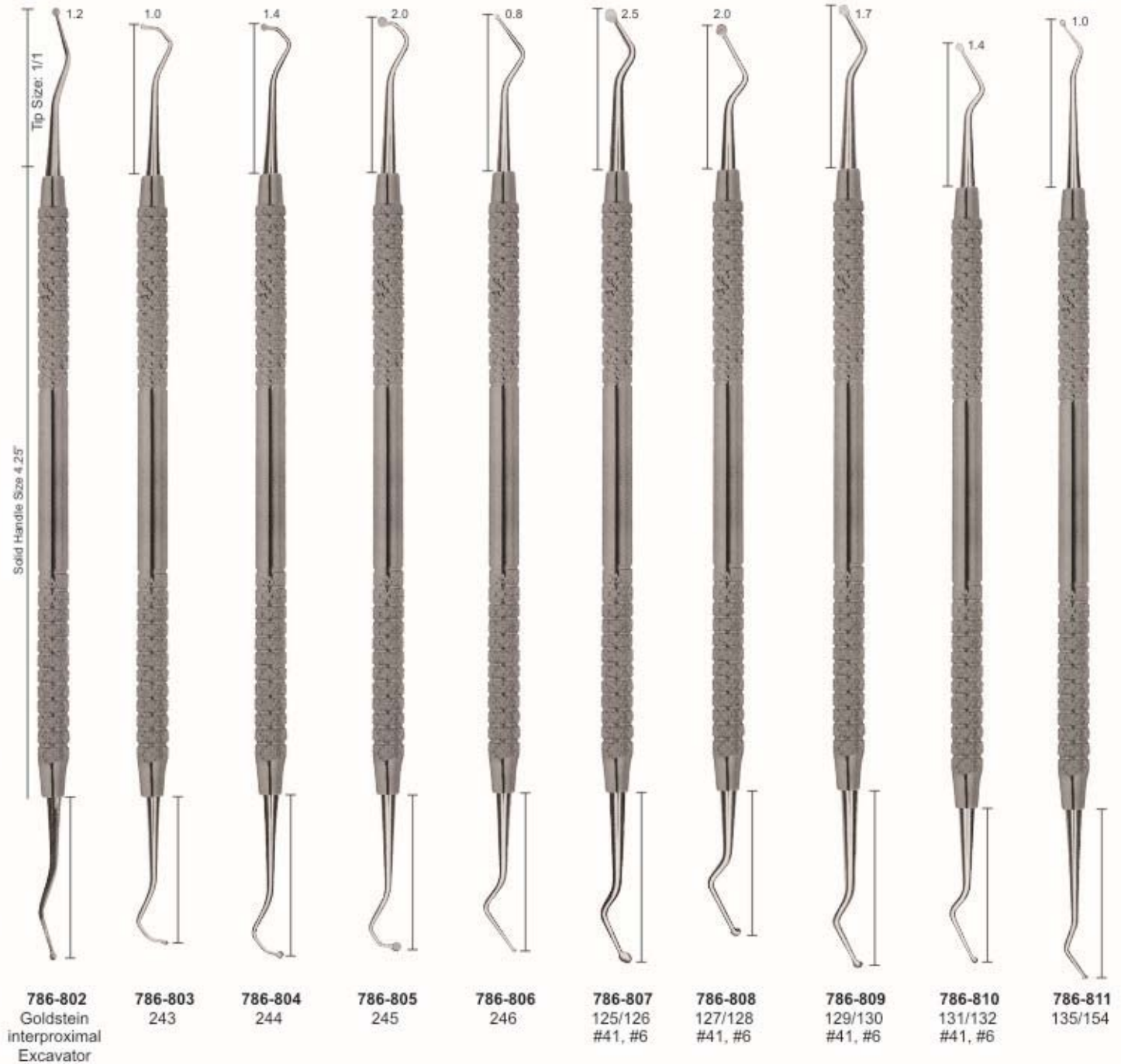

FILLING INSTRUMENTS

- Инструменты для реставрации
- Instruments pour plombage
- Füllungsinstrumente (mit Kontrawinkel)

- Інструменти для реставрації
- Instrumentos para obturaciones
- ملء الصكر



HATCHETS

RESTORATIVE INSTRUMENTS SOLID HANDLE 6MM, LENGTH 170MM

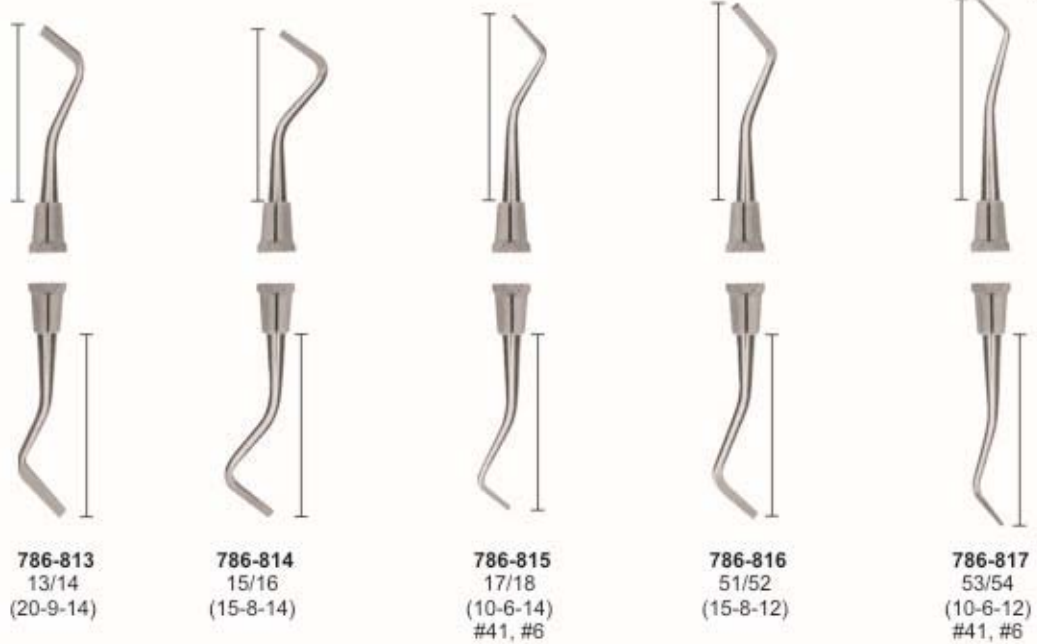

ANTERIOR



FILLING INSTRUMENTS

- Инструменты для реставрации
- Instruments pour plombage
- Füllungsinstrumente (mit Kontrawinkel)

- Инструменти для реставрації
- Instrumentos para obturaciones
- مل، المسكوك

CARVERS

RESTORATIVE INSTRUMENTS SOLID HANDLE 6MM, LENGTH 170MM



786-827
Inter-proximal
Off-Angle



786-828
1/2-3
Hollenback
#41, #6,
#7, #8



786-829
3S
Hollenback
#41, #6, #7



786-830
3
Hollenback



786-831
8
Wiland
Minn. IPC1
#41, #6, #7

TANNER

WALL

WARD



786-832
3
Tanner



786-833
4
Tanner



786-834
5
Tanner



786-835
6
Tanner



786-836
1
Wall



786-837
3
Wall



786-838
1
Ward



786-839
2
Ward

786-826
Inter-proximal
#41, #6, #7

AMALGAM CARVERS

■ Инструменты для реставрации
 ■ Instruments pour amalgama
 ■ Amalgampistolen

■ Инструменти для реставрації
 ■ Instrumentos para amalgama
 ■ لتطبيع السلفم

RESTORATIVE INSTRUMENTS
SOLID HANDLE 6MM, LENGTH 170MM

ANDREW



786-841
2 Andrew

786-842
3 Andrew

786-843
4 Clappison

786-844
2/3 Frahm #41, #6

786-845
104

CLAPPISON/FRAHAM

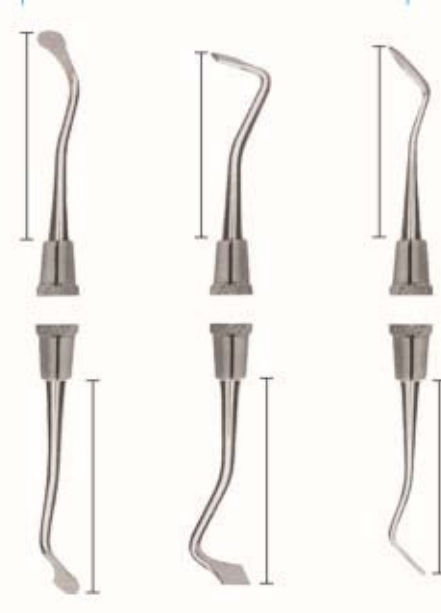

786-843
4 Clappison

786-844
2/3 Frahm #41, #6

786-845
104

HOLLENBACK



786-846
1 Hollenback
2 Modified Cleoid Small

786-847
1 Hollenback
2 Modified Cleoid Large

786-848
1 Hollenback

786-849
2 Hollenback

HOLLENBACK



786-840
1 Andrew

786-848
1 Hollenback

786-849
2 Hollenback

THARP

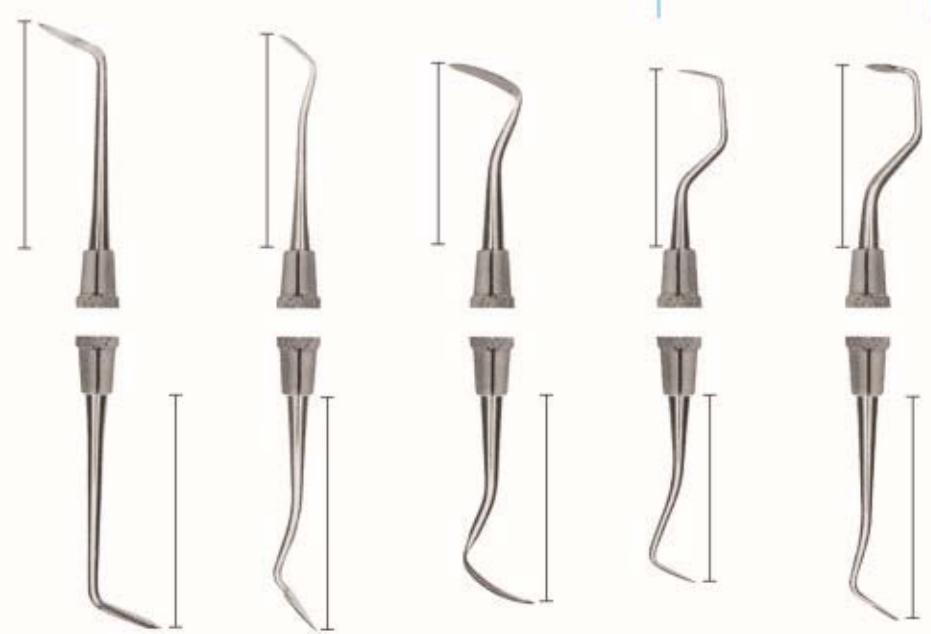

786-850
L7 Levy

786-851
SHO-A Shoshan

786-852
18 Sprengel

786-853
1 Tharp

786-854
2 Tharp

0
1
2
3
4
5
6
7
8
9
10
Inch

AMALGAM CARVERS

■ Инструменты для реставрации
 ■ Instruments pour amalgama
 ■ Amalgampistolen

■ Инструменты для реставрації
 ■ Instrumentos para amalgama
 ■ تطعيج السلفم

RESTORATIVE INSTRUMENTS SOLID HANDLE 6MM, LENGTH 170MM

CARVERS

AMALGAM FILES

HOES

Forming Line Angle on Anterior Preparations



786-856
Discoid-Cleoid
Carver

786-857
31/32
Rhein

786-858
1/4
Wedelstaedt

786-859
2/5
Wedelstaedt

DISCOID CLEIDS

DISCOID CLEIDS



786-855
Anatomical
Carver

786-860
1/2

786-861
4/5
#41, #6, #7

786-862
3/6
#41, #6, #7



786-864
21
(10-4-8)

786-865
22
(10-4-14)

786-866
23
(6.5-2.5-9)

786-863
20
(14-6-8)

786-867
89/92
#41, #6, #7

786-868
90B

786-869
89/92
W-A-C-D

FILLING INSTRUMENTS

- Инструменты для реставрации
- Instruments pour plombage
- Füllungsinstrumente (mit Kontrawinkel)

- Инструменти для реставрації
- Instrumentos para obturaciones
- ملء الصكوك

RESTORATIVE INSTRUMENTS
SOLID HANDLE 6MM, LENGTH 170MM

MARGIN TRIMMERS



786-870
26
(13-95-8-14)
Distal



786-871
27
(13-80-8-14)
Mesial



786-872
27
(10-95-8-14)
Distal
#41, #6



786-873
29
(10-80-7-14)
Mesial
#41, #6



786-874
77/78
(15-95-8-12)
Distal



786-875
79/80
(15-80-8-12)
Mesial

ANGLE FORMERS



786-876
30/31
(12-80-5-8)



786-877
32/33
(9-80-4-8)



786-878
34/35
(7-80-2.5-9)



CARVERS INSTRUMENTS

- Инструменты для реставрации
- Instruments a modeler
- Modellerinstrumente

- Инструменти для реставрації
- Instrumentos para modelar
- أدوات تنطبع

P.K. THOMAS WAXING INSTRUMENTS SOLID HANDLE 6MM, LENGTH 170MM

P.K. THOMAS WAXING INSTRUMENTS

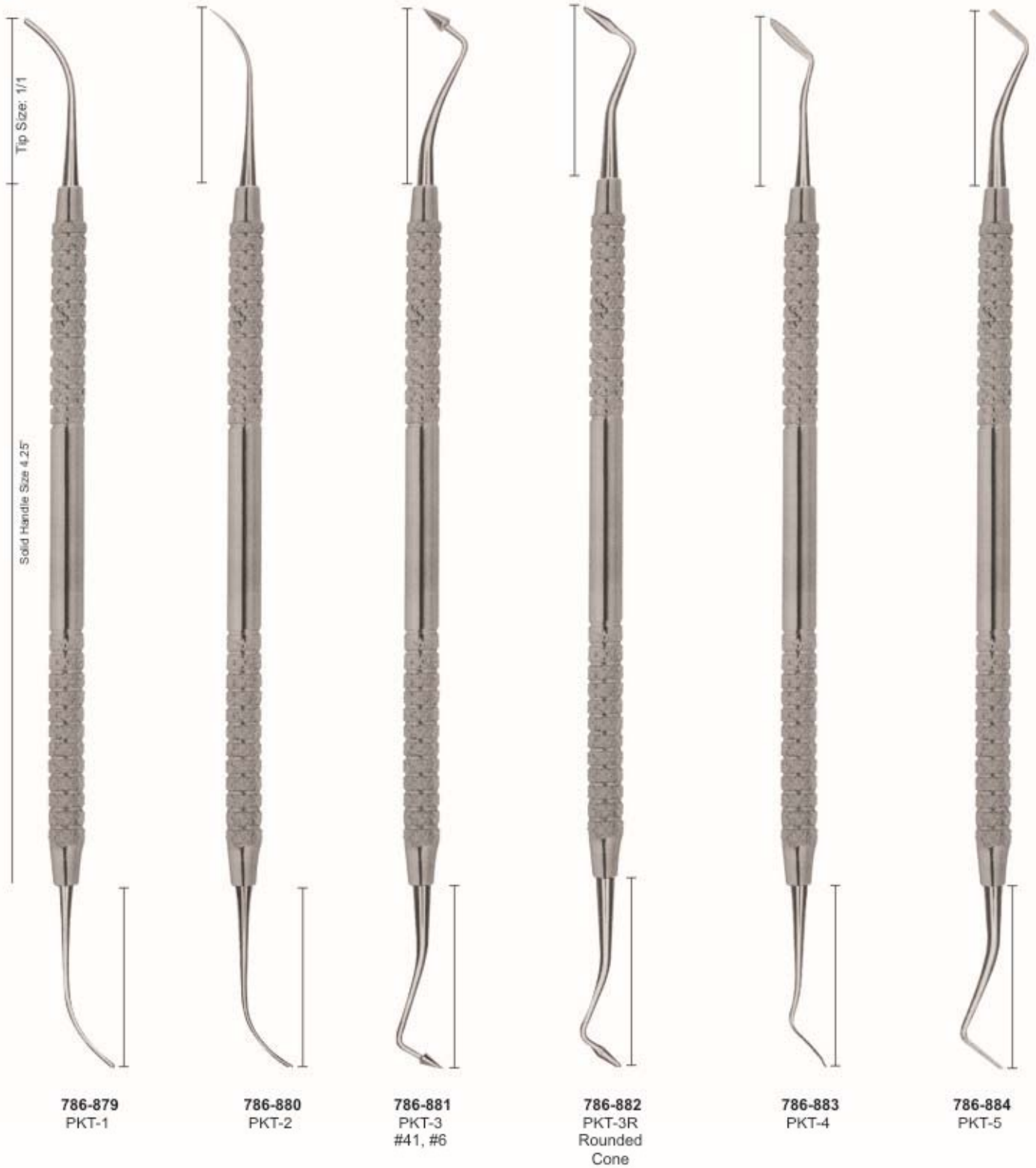

FILLING INSTRUMENTS

- Инструменты для реставрации
- Instruments pour plombage
- Füllungsinstrumente (mit Kontrawinkel)

- Інструменти для реставрації
- Instrumentos para obturaciones
- مل، المسكوك

CHISELS

HOES

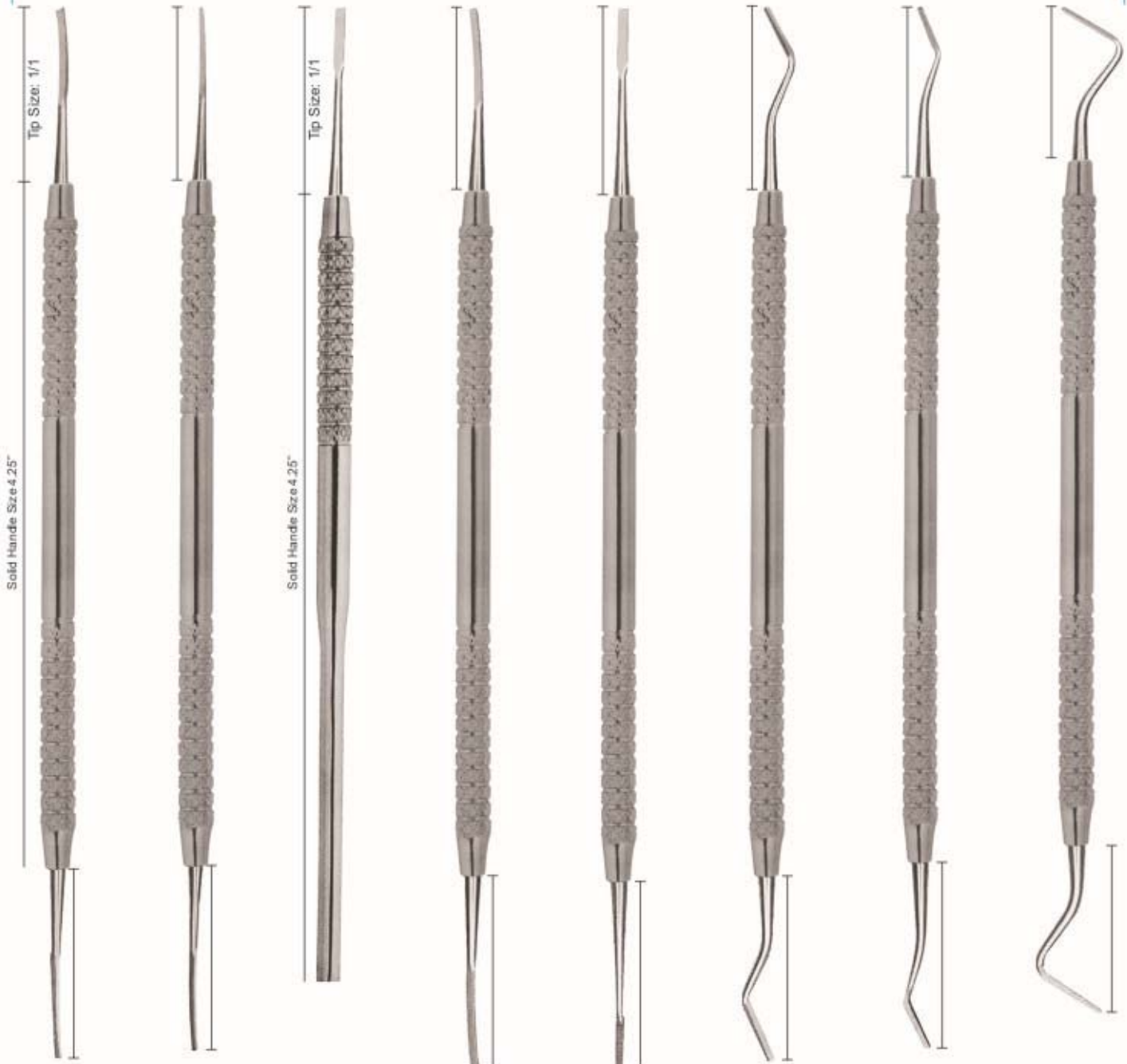

786-885
1/2
Werdelstaedt
(20-15-3)

786-886
3/4
Werdelstaedt
(11.5-15-3)

786-887
7
Straight
(15)

786-888
5/6
Straight
(15-15-3)

786-889
7/10
Straight
(15) (20)

786-890
8/9
Binangle
(20-9-8)

786-891
11-12
Binangle
(20-8-8)

786-892
40/41
Binangle
(18-10-16)



CEMENT SPATULAS

■ Шпатели для цемента
 ■ Spatules à ciment
 ■ Zementspatel

■ Шпателі для цементу
 ■ Espátulas para cemento
 ■ ملاحق الاسمنت

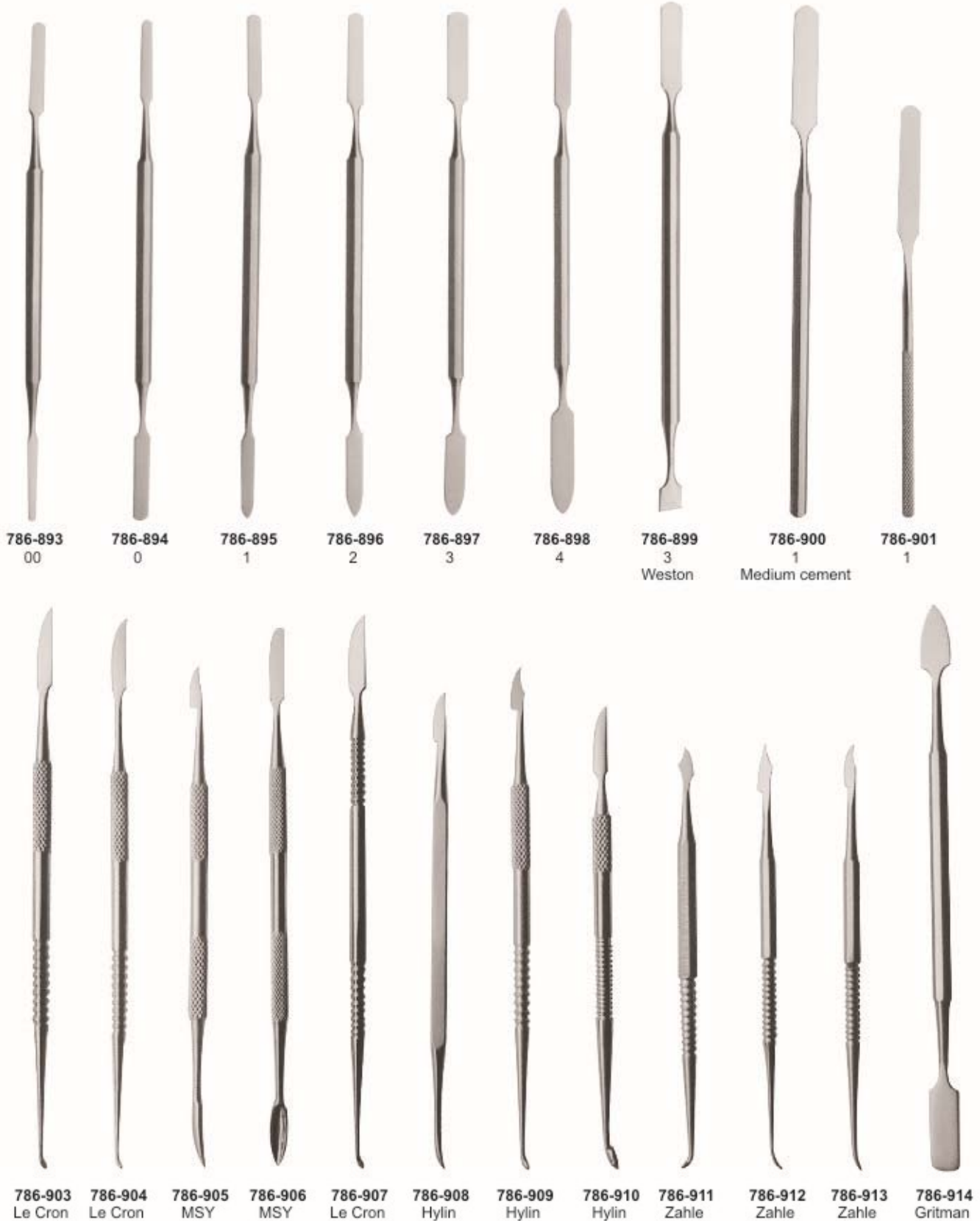
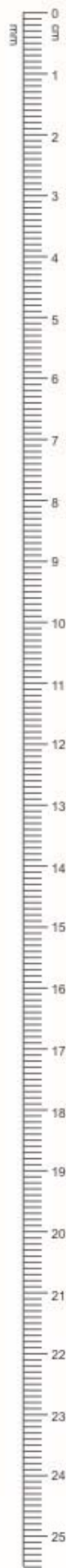

786-893 00	786-894 0	786-895 1	786-896 2	786-897 3	786-898 4	786-899 3 Weston	786-900 1 Medium cement	786-901 1				
786-902 Le Cron	786-903 Le Cron	786-904 Le Cron	786-905 MSY	786-906 MSY	786-907 Le Cron	786-908 Hylin	786-909 Hylin	786-910 Hylin	786-911 Zahle	786-912 Zahle	786-913 Zahle	786-914 Gritman

WAX KNIVES

- Ножи для воска
- Couteaux a cire
- Wachsmesser

- Ножи для воску
- Cuchillos para cera
- السكاكين الشمع

ALGINATE, PLASTER SPATULAS, WAX KNIVES PLASTER FOR KNIVES & PLASTER SHEAR



786-915
Wooden Handle
Fig. 5
21.5 cm



786-916
Wooden Handle
Fig. 7
19.5 cm curved



786-917
Wooden Handle
Fig. 8
20 cm curved



786-918
Wooden Handle
Fig. 9
22.5 cm curved



786-919
Hook Knives



786-920
Fig. 1
Lessmann
12.5 cm



786-921
Fig. 2
Lessmann
17 cm



786-922
Fig. 1
with small spoon
12.5 cm



786-923
Fig. 2
with large spoon
17 cm



786-924
Bacolite Handle
Wax Knives,
Small



786-925
Bacolite Handle
Wax Knives,
Large



786-926
Wooden Handle
Wax Knives,
Small



786-927
Wooden Handle
Wax Knives
Large



786-928
Plaster Knives



786-929
Fig. 1
17 cm



786-930
Fig. 3
16 cm



786-931
Fig. 4
16 cm



786-932
Special Inox
19.5 cm

ARTICULATORS

- Артикуляторы
- Artocilar
- Artikulations

- Артикулятори
- Articuler
- ارتیکولاتورس



786-933

Technical Datas:

Intercondylar distance
condylar inclination
Bennet angle
Incisal table inclination
Distance between mounting plates
Weight
Opening (Item 5000)
Opening (5010)

120 mm
fixed at 30°
fixed at 7°
10°
85 mm
400 gr.
125°
180°

786-934

Technical Datas:

Intercondylar distance
condylar inclination
Bennet angle
Incisal table inclination
Distance between mounting plates
Weight
Opening

110 mm
fixed at 30°
fixed at 7°
flat
85 mm
45 gr.
180°

786-935

Stainless Steel Finishing
786-936
Royal Blue



786-937



786-938



786-939



786-940



786-941



786-942



786-943



786-944



786-945



786-946

Nakawalni
Dental Laboratory
Instrument

MAXILLOFACIAL SURGERY INSTRUMENTS

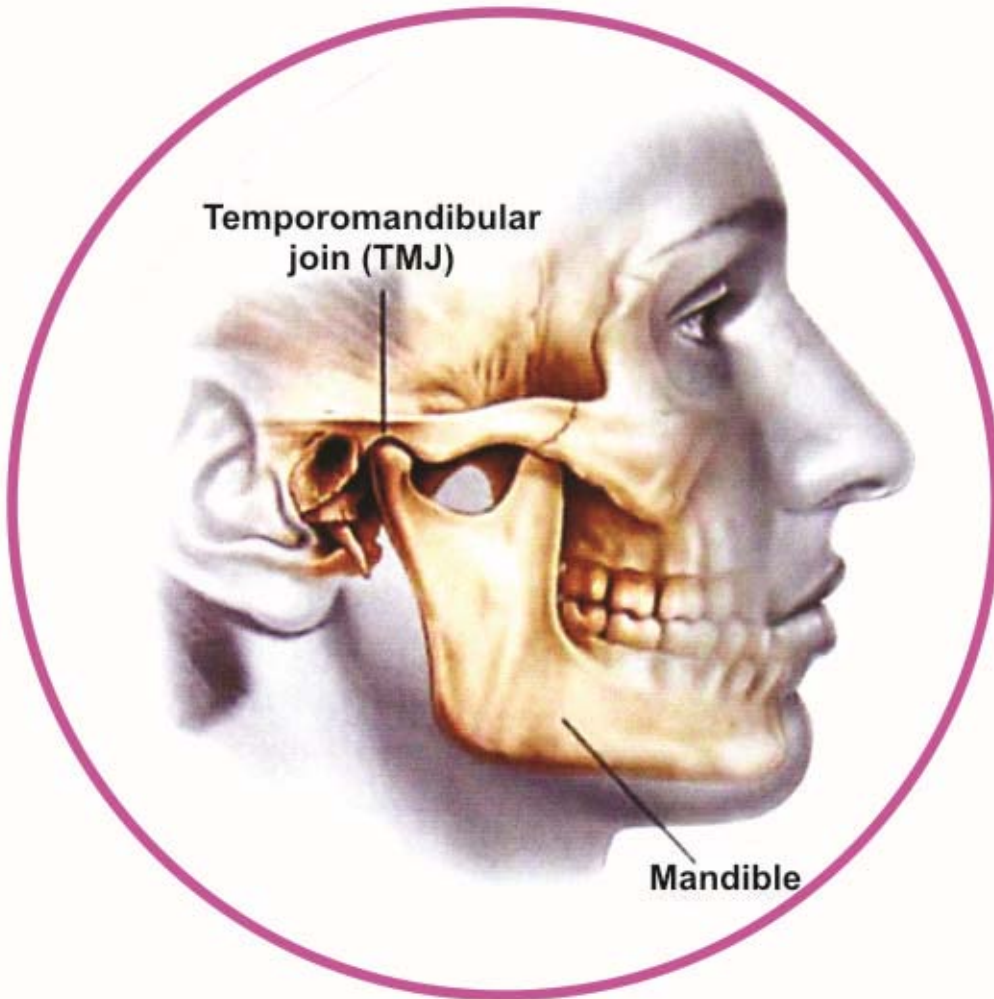

RETRACTORS - MOUTH GAGS

- Роторасширители
- Ecarteurs - Ouvre-bouches
- Vesibulumabhalter / Mundspanner

- Роторозширювачі
- Separadores-Abre-bocas
- الكاشحات، الكشبات، الفم



786-947
Mouth Gag Molt
11 cm for (Children)



786-948
Mouth Gag Molt
14 cm for (Adults)



Cheek Retractor
786-949 140 mm
786-950 180 mm



Cheek Retractor
786-951 140 mm



786-952
Wangen Holder,
vestibule 15 cm,
with or without
lip protection,



786-953
Wangen Holder,
vestibule 15 cm,
with or without
lip protection,



786-954
Wangen Holder,
Wangen holder with dual
function, 17 cm,



786-955
140 mm

786-956
150 mm

Cheek Retractor

RETRACTORS - MOUTH GAGS

- Роторасширители
- Ecarteurs - Ouvre-bouches
- Vesibulumabhalter / Mundspanner

- Роторозширювачі
- Separadores-Abre-bocas
- الكاشحات،الكشامات،الم



786-957
Fig. 1
Weitlaner
10.5cm
13.5cm



786-958
Fig. 2
Weitlaner
10.5cm
13.5cm



786-959
Stainless Steel
Double
Ended Cheek
Retractors



786-960
Stainless Steel
Single
Ended Cheek
Retractors



Weitlander
786-961 11 cm
786-962 13 cm
786-963 15 cm



786-967
Denhard
12 cm



786-968
Roser-König
16 cm



786-969
Roser-König
19 cm



Jennings
786-964 11 cm
786-965 13 cm
786-966 15 cm

RETRACTORS

Wound, Bendable
Retractor, individually or as saving kit!

■ Роторасширители
■ Ecarteurs
■ Wundhaken

■ Роторозширювачі
■ Separadores
■ الكاشحات



786-970
Cheek Retractor
Long



786-971
Cheek Retractor
Long



786-972
Cheek Retractor
Long



**Retractor with
Ergo Grip**
786-973 24 cm
Ergonomic handle



786-974
Cheek Retractors,
Retractor Ivory
Width adjustable
& fixable, 20 cm



**Cheek Retractors,
Tongue Depressors**
786-975 19 cm



**Cheek Retractors,
Minnesota**
786-976 16 cm



Cheek Retractors,
786-977 20 cm
easy to bend
by hand,



Cheek Retractors,
Retractor and tongue
pushers BISHOP with
comfortable margin,
786-978 16 cm,



Cheek Retractors,
Retractor combination
combination,
786-979 25 cm,

RETRACTORS

- Роторасширители
- Ecarteurs
- Wundhaken

- Роторозширювачі
- Separadores
- الكاشطات



786-982
Retractors, Unique
Length 175 mm
angled 45°



786-983
Retractors, Unique
Length 175 mm
angled 90°



786-984
Retractors,
16 cm



786-985
Retractors,
19 cm



786-986
Retractors, Mini-Langenbeck
16 cm, hooks 22 mm,



786-987
Retractors, Cheek
Retractor combination
21 cm, 2



786-988
Mini Retractor
about 8 cm,



786-989
Retractors,
17 cm, hooks 22 mm



RETRACTORS

■ Роторасширители
 ■ Ecarteurs
 ■ Wundhaken

■ Роторозширювачі
 ■ Separadores
 ■ الكاشحات



30 x 16 mm

786-990
Retractors, surgical-flat
surgically-flat, 21 cm, hook
30 x 16 mm



786-991
Retractors, surgical-flat
surgically-flat, 21 cm, hook
42 x 11 mm



60 x 12 mm

786-992
Retractors, surgical-flat
surgically-flat, 21 cm, hook
63 x 12 mm



Retractors, surgical-flat
surgically-flat, 21 cm, hook
786-993 30x16 mm
786-994 42x11 mm
786-995 63x12 mm



Retractors, Lengenbeck
21 cm, hook
786-996 30x11 mm
786-997 30x16 mm



786-998
Retractors
21 cm



786-999
Farabeuf
(120 x 12mm)
Set of 2 pieces



786-1000
Retractor Seldin



786-1001
FELDMAN
Retractor
5-1/2", 14cm

GUM SCISSORS

- Ножницы десневые
- Ciseaux a gencives
- Zahnfleischscheren

- Ножиці для ясен
- Tijeras para encias
- مقصص صمغ



786-1002
Iris
115mm
Straight



786-1003
Iris
115mm
Curved



786-1004
Goldman-Fox
130mm
Saw edge, straight



786-1005
Goldman-Fox
130mm
Saw edge, Curved



786-1006
La Grang
115mm
Saw edge, double Curved



Mayo
786-1007 140mm
786-1008 170mm
786-1009 230mm
Straight



Mayo
786-1010 140mm
786-1011 170mm
786-1012 230mm
Curved



Metzenbaum
786-1013 145mm
786-1014 180mm
786-1015 200mm
Straight



Metzenbaum
786-1016 145mm
786-1017 180mm
786-1018 200mm
Curved



786-1019
Kelly
160mm
Straight



786-1020
Kelly
160mm
Curved



786-1021
Iris
115mm
Straight



786-1022
Iris
115mm
Curved



786-1023
La Grange
115mm
Double Curved



786-1024
Goldman-fox
130mm,
Straight



786-1025
Goldman-fox
130mm,
Curved



786-1026
Kelly
160mm, curved



786-1027
Iris
115mm, Straight



786-1028
Iris
115mm, Curved



786-1029
Micro Iris
90mm, Curved

GUM SCISSORS

- Ножницы десневые
- Ciseaux a gengives
- Zahnfleischscheren

- Ножиці для ясен
- Tijeras para encias
- مقصص



786-1030
Iris
115mm,
Angled



786-1031
Iris
115mm,
Curved



786-1032
Goldman-Fox
130mm,
Saw edge, straight



786-1033
Goldman-Fox
130mm,
Saw edge, curved



786-1034
Goldman-Fox
130mm,
Saw edge,
double curved



786-1035
La Grange
115mm,
Saw edge,
double curved



786-1036
Neumann
120mm,
Saw edge,
double curved



786-1037
Kilner (Ragnell)
120mm,
Straight



786-1038
Kilner (Ragnell)
120mm,
Curved



786-1039
Joseph
140mm,
Straight



786-1040
Joseph
140mm,
Curved



786-1041
Kelly
160mm,
Straight



786-1042
Kelly
160mm,
Curved



786-1043
Lockin
160mm,
Saw edge,
angular



786-1044
Lockin
120mm,
160mm
Saw edge,
angular



786-1045
Dean
170mm,
Saw edge,
angular



786-1046
Spencer
90mm



786-1047
Spencer
130mm



786-1048
Spencer
115mm



786-1049
Noyes
110mm, straight



786-1050
Noyes
110mm, curved



786-1051
Noyes
110mm,
Angular



786-1052
Castroviejo
150mm
Curved

NEEDLE HOLDERS

■ Иглодержатели
■ Porte-aiguilles
■ Nadelhalter

■ Голкотримачи
■ Porta-agujas
■ اصحاب ابرة



786-1053
130mm
Straight



786-1054 Mayo 130mm
786-1055 Mayo 160mm
786-1056 Mayo 180mm
straight curved



786-1057 Mayo 140mm
786-1058 Mayo 200mm
straight curved



786-1059 Metzenbaum 145mm
786-1060 Metzenbaum 200mm
straight curved



786-1061
Beebee 110mm
Saw edge, straight



786-1062
Beebee 110mm
Saw edge, curved



786-1063
Beebee 110mm
Saw edge, straight



786-1064
Beebee 110mm
Saw edge, curved



786-1065
Universal 120mm



786-1066
Universal 120mm

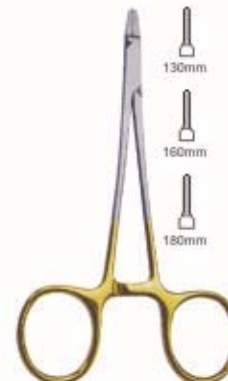

786-1067 Crile 130mm
786-1068 Crile 150mm
786-1069 Crile 180mm



786-1070
Halsey 130mm



786-1071
Baumgartner 130mm



786-1072
Derf 120mm



786-1073
Delicate 150mm



786-1074 Mayo-Hegar 130mm
786-1075 Mayo-Hegar 160mm
786-1076 Mayo-Hegar 180mm
786-1077 Mayo-Hegar 200mm



786-1078
Crile-Wood 150mm
straight



786-1079
Crile-Wood 150mm
curved



NEEDLE HOLDERS

■ Иглодержатели
■ Porte-aiguilles
■ Nadelhalter

■ Голкотримачи
■ Porta-agujas
■ اصحاب ابرة



Castroviejo
786-1080 130mm
786-1081 150mm
786-1082 180mm



786-1083
Halsey
130mm



786-1087
Baumgartne
130mm



786-1085
Derf
120mm



786-1086
Delicate
150mm



786-1087
Adson
170mm



Mayo-Hegar
786-1088 130mm
786-1089 160mm
786-1090 180mm
786-1091 200mm



786-1092
Crile-Wood
150mm



Castroviejo
786-1093 str 140mm cvd
786-1094 str 180mm cvd



Olsen-Hegar Needle
Holder with Scissors
786-1095 140mm



Gillies Needle
Holder with Scissors
786-1096 160mm



Mathieu
786-1097 140mm
786-1098 170mm



Castroviejo
786-1099 str 140mm cvd
786-1100 str 180mm cvd



Olsen-Hegar Needle
Holder with Scissors
786-1101 140mm



Gillies Needle
Holder with Scissors
786-1102 160mm



Hartmann (Baby Mosquito)
786-1103 90mm straight



Halstead Mosquito
786-1105 125mm
Straight

786-1104
125mm
Curved

786-1106
Curved

HAEMOSTATIC FORCEPS & TOWEL CLAMPS

- Зажимы артериальные, зажимы для салфеток
- Pincers hemostaticques, Pincers a compresses
- Arterienklemmen, Tuychklemmen

- Затискачі артеріальні, затискачі для серветок
- Pinzas hemostaticas, Pincers para compressas
- الملقط هایو ستاتیک المشابک بنشفة



786-1108
curved

Halstead Mosquito 1x2
786-1107 125mm
straight



786-1110
curved

Kelly
786-1109 140mm
straight



786-1115 140mm
786-1116 160mm
786-1117 180mm
786-1118 200mm
curved

Rochester-Pean
786-1111 140mm
786-1112 160mm
786-1113 180mm
786-1114 200mm
straight



786-1123 140mm
786-1124 160mm
786-1125 180mm
786-1126 200mm
curved

Rochester-Kocher 1x2
786-1119 140mm
786-1120 160mm
786-1121 180mm
786-1122 200mm
straight



786-1128
curved

786-1127
Kelly-Rankin
160mm
straight

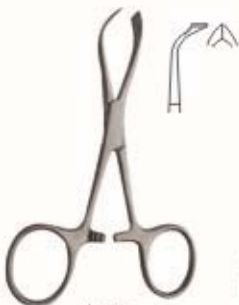

Lorna
786-1129 100mm
786-1130 130mm



786-1131
Allis-Baby 3:4
150mm



786-1132
Allis 4:4
200mm



786-1133
Allis 6:7
200mm



Backhaus
786-1134 140mm
Not-perforating and
not-damaging



786-1135
Backhaus
130mm



786-1136
Backhaus
85mm



786-1137
Jones
90mm



786-1139
curved

Gross Maier
Dressing Forceps
786-1138 200mm straight



Foerster
Dressing Forceps
786-1140 200mm



Young
Tongue Forceps
786-1141 170mm

Spare rubber



Collins
Tongue Forceps
786-1142 170mm

RUBBER DAM CLAMPS FORCEPS

■ Инструменты для системы коффердам
 ■ Pinces porte-crampons a digue
 ■ Kofferdam Klammerzangen

■ Инструменти для системи коффердам
 ■ Pinzas de engrapar para dique de caucho
 ■ السد المصنوع الملقط المشابك



786-1143

On request the Content of the rubber dam kit can be changed with other instruments.

Content:

01 Anisworth

02 Brewer

03 Clamps Stand

04 Denture Plate

05 Rubber Dam Frame

06 Rubber Dam Box Lower Case

07 Rubber Dam Box Upper Case

08 Rubber Dam Clamp Fig. 212

09 Rubber Dam Clamp Fig. 211

10 Rubber Dam Clamp Fig. 8

04 Rubber Dam Clamp Fig. 8A

05 Rubber Dam Clamp Fig. 14

06 Rubber Dam Clamp Fig. 14A

07 Rubber Dam Clamp Fig. 0

07 Rubber Dam Clamp Fig. 00

07 Rubber Dam Clamp Fig. 2

07 Rubber Dam Clamp Fig. 2A

07 Rubber Dam Clamp Fig. 7



786-1144
Anisworth



786-1145
Brewer



786-1146
Ivory light weight



786-1147
Palmer



786-1148
Separating
Elastic
Plier

RUBBER DAM CLAMPS

■ Кламмера для коффердама
 ■ Crampons pour digue
 ■ Kofferdam Klammern

■ Кламмера для коффердама
 ■ Grapas para dique de caucho
 ■ المشابك السد المصنوع من المطاط



786-1149
Fig. 15



786-1150
Fig. 18



786-1151
Fig. 24



786-1152
Fig. 25



786-1153
Fig. 26



786-1154
Fig. 28



786-1155
Fig. 30



786-1156
Fig. 31



786-1157
Fig. 51



786-1158
Fig. 138



786-1159
Fig. 139



786-1160
Fig. 200



786-1161
Fig. 201



786-1162
Fig. 202



786-1163
Fig. 203



786-1164
Fig. 204



786-1165
Fig. 205



786-1166
Fig. 3



786-1167
Fig. W3



786-1168
Fig. 4



786-1169
Fig. 56A



786-1170
Fig. 7



786-1171
Fig. 7A



786-1172
Fig. 8



786-1173
Fig. 8A



786-1174
Fig. W8A



786-1175
Fig. 10



786-1176
Fig. 11



786-1177
Fig. 12A



786-1178
Fig. 13A



786-1179
Fig. 14



786-1180
Fig. 14A



786-1181
Fig. 14AN



786-1182
Fig. 22



786-1183
Fig. 27



786-1184
Fig. 207



786-1185
Fig. 29



786-1186
Fig. 206



786-1187
Fig. 208



786-1188
Fig. 209



786-1189
Fig. 1



786-1190
Fig. 1A



786-1191
Fig. 2



786-1192
Fig. 2A



786-1193
Fig. W2A



786-1194
Fig. 0



786-1195
Fig. 00



786-1196
Fig. 210



786-1197
Fig. 211



786-1198
Fig. 212



786-1199
Fig. 6



786-1199
Fig. 6



786-1200
Fig. 9



786-1200
Fig. 9



786-1201
Fig. N06



786-1202
Fig. U67



786-1203
Fig. 214



786-1204
Fig. P1



786-1205
Fig. P2



786-1206
Fig. G-1



786-1207
Fig. G-2

CROWN REMOVER

- Инструменты для удаления коронок
- Arrche-couronnes
- Teleskopkronenzangen

- Инструменты для видалення коронок
- Arranca-corona
- مزيلات التاج



786-1210
Crown Spreaders



786-1211
Mershon
14 cm
Band Pusher



786-1212
Fig. 0



786-1213
Manual
Crown Remover



786-1214
Complete with 3 tips
and tightening keys

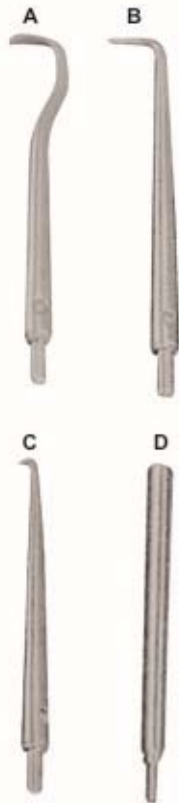

semi-automatic crown
& bridge remover



786-1215



786-1216
Manual Crown Remover



MATRIX RETAINERS

- Матрицедержатели
- Porte Matrices
- Matrizenspanner

- Матрицеутримувачи
- Porta Matrices
- مصفوفة الخدم



786-1217
Fig. 5
Ivory 8
5 cm



786-1218
Fig. 6
Ivory 8
6 cm



786-1219
Fig. 7
Ivory 8
7 cm



786-1220
Fig. 1
Tofflemire-Universal



786-1221
Fig. 2
Tofflemire-Junior



786-1222
Fig. 3
Tofflemire-Senior



786-1223
Narrow



786-1224
Wide

Siqveland retainers

Amalgam Well



786-1225
Stainless Steel
Amalgam Well



786-1226
Ivory 12



786-1227
Ivory 1



786-1228
Ivory



786-1229
Elliot



AMALGAM INSTRUMENTS & SCALPEL HANDLES

■ Инструменты для амальгамы
■ Instruments pour amalgame
■ Amagamis/ nstrumente

■ Инструменти для амальгами
■ Instrumentos para amalgama
■ السكوك الفلغ

■ Ручки для скальпелей
■ Manches de bistouris
■ Skalpellgriffe

■ Ручки для скальпелів
■ Mangos de bisturi
■ مشرط مقابض



786-1230
Fig. 10
165mm
English pattern



786-1231
Fig. 1
185mm
German pattern



786-1232
Fig. 1
150mm
Swiss pattern



786-1233
Fig. 1
150mm



786-1234
Fig. 2
150mm, 45°



786-1235
Fig. 3
140mm, 90°



786-1236
Fig. 3
5" (12.7cm)



786-1237
Fig. 3G
5" (12.7cm)



786-1238
Fig. 4
5 1/2"(13.7cm)



786-1239
6 Way Adjustable Angled
Scalpel Handle



Locks at 90°, 60°, 30°
Straight, 120°, 150°, 180°
Angles

AMALGAM INSTRUMENTS

- Инструменты для амальгамы
- Instruments pour amalgame
- Amagamis/ nstrumente
- Инструменти для амальгами
- Instrumentos para amalgama
- الصكوك الملعق

AMALGAM CARRIERS



786-1240
Distal
Improves visibility
and access to
posterior regions

786-1241
Single-End

786-1242
Double-End

TIP SIZES FOR DOUBLE-END

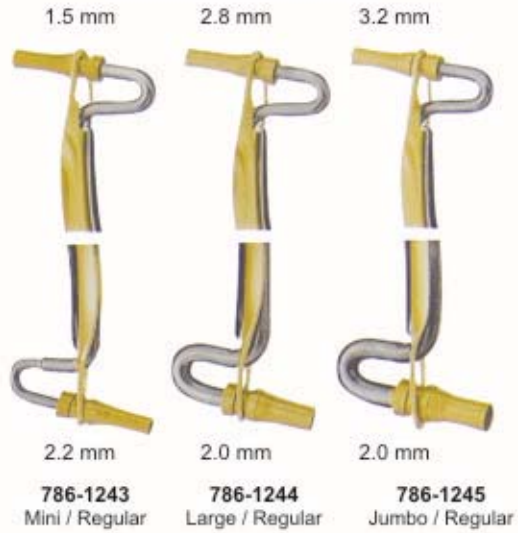

786-1243
Mini / Regular

786-1244
Large / Regular

786-1245
Jumbo / Regular

TIP SIZES FOR DISTAL OR SINGLE-END

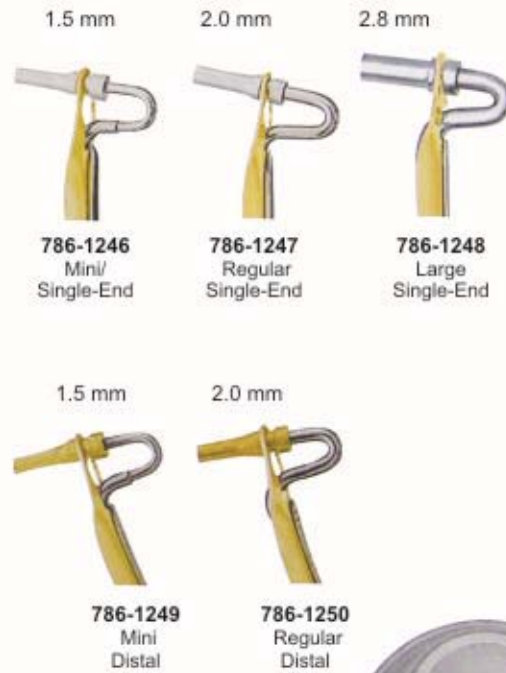

786-1246
Mini/
Single-End

786-1247
Regular
Single-End

786-1248
Large
Single-End

786-1249
Mini
Distal

786-1250
Regular
Distal



786-1251
Amalgam
Well



ROOT PLANNING FILES & BONE FILES

ROOT PLANNING FILES



786-1252
Kramer-Nevins
Bone Chisel



786-1253
Kramer-Nevins
Bone Chisel



786-1254
Molt 18.5cm
Auto Cleavable
Plastic Tips



786-1255
Mead 18.5cm
Non Auto Cleavable
Plastic Tips.



786-1256
Miller



786-1257
Miller

BONE FILES



786-1258
Miller 21



786-1259
Miller 1X
cross cut



786-1260
Miller 2X
Cross cut



786-1261
Miller 52



786-1262
Wahl 1

PERIODONTAL INSTRUMENTS

- Инструменты пародонтологические
- Instruments pour la parodontologie
- Instrumente für die Parodontologie

- Інструменти пародонтологічні
- Instrumentos para periodoncia
- الصكوك اللثة

PERIOSTEEL ELEVATORS

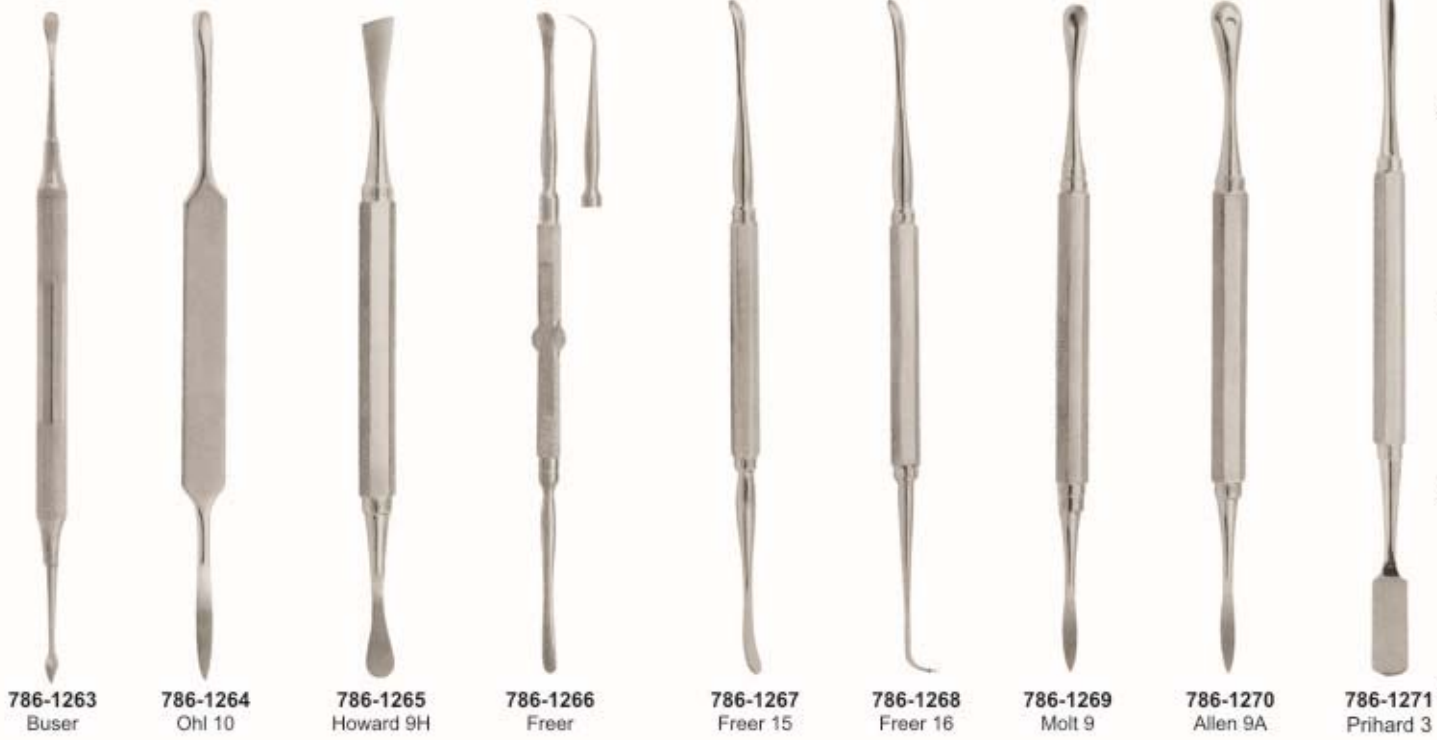

786-1263 Buser 786-1264 Ohl 10 786-1265 Howard 9H 786-1266 Freer 786-1267 Freer 15 786-1268 Freer 16 786-1269 Molt 9 786-1270 Allen 9A 786-1271 Prihard 3



786-1272 Seldin 23 786-1273 Goldman-Fox 14 786-1274 P 24G 786-1275 Raspator, Raspatory Length 175mm, 786-127A Raspatory 786-127B Raspatory 786-1276 Raspator, Williger Length 170 mm, different widths (4mm, 5mm, or 7mm) 786-1276A Raspatory 786-1276B Raspatory



ORTHODONTIC INSTRUMENTS



Behind Every Smile is a Story

● QUALITY - ЯКІСТЬ ● PRECISION - ТОЧНІСТЬ ● ACCURACY - ПРАВИЛЬНІСТЬ ● DURABILITY - ЗНОСОКОТІЙКІСТЬ



STYLE A

- Super-sharp dual overhauled cutters
- Smooth extra polished and fire finished edges
- Crucial corrosion resistant stainless steel body
- Sliding lock joint for tension & pressure adjustment
- Superior T-12 stainless steel tool inserts

STYLE B

- Facer sharp dual overhauled cutters
- Smooth extra polished and fire finished edges
- Crucial corrosion resistant stainless steel body
- Sliding lock joint for tension & pressure adjustment
- Superior T-12 stainless steel tool inserts

ORTHODONTIC INSTRUMENTS

■ Инструменты ортодонтические
 ■ Instrumentos Ortodonticos
 ■ Orthodontische Instrumente

■ Інструменти ортодонтичні
 ■ Instruments Orthodontiques
 ■ ادوات لتقويم الأسنان



786-1277
 Aluminium Height
 Gauge 0.22



786-1278
 Aluminium Height
 Gauge 0.18



786-1279
 Bone Bracket Gauge



786-1280
 Bone Thickness Gauge
 40mm, 180mm



786-1281 OSTEOMETER
 Measuring Forceps for Jaw
 Ridge Width measurement, scale
 on both sides, rustree, autoclavable



786-1282
 Direct bonding
 Bracket holders,
 135mm



786-1283
 Deluxe Bracket
 holder Tweezers



786-1284
 Direct bonding
 Bracket holders,
 136mm



786-1285
 Direct Bond
 Bracket holders,
 Tweezers,
 Small Tip



786-1286
 Direct Bonding
 Bracket holders,
 140mm



786-1287
 Direct Bonding
 Bracket holders,
 135mm



786-1288
 Direct Bonding
 Bracket holders,
 140mm

ORTHODONTIC INSTRUMENTS

■ Инструменты ортодонтические
■ Instrumentos Ortodonticos
■ Orthodontische Instrumente

■ Инструменти ортодонтичні
■ Instruments Orthodontiques
■ أدوات تقويم الأسنان



786-1289
Band seater auto cleavable

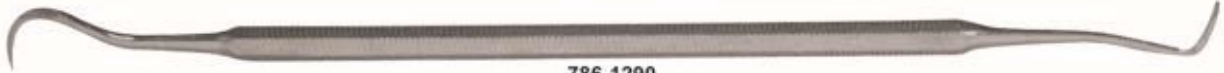

786-1290
Ortho light scaler double ended



786-1291
Ortho light scaler double ended



786-1292
Ortho light scaler double ended



786-1293
Twiel-on elastic module instrument



786-1294
Twiel-on elastic module instrument



786-1295
Schure Band Seater



786-1296
Ortho light scaler



786-1297
Ortho light scaler



786-1298
Ortho light scaler heavy



786-1299
Ortho instrument



786-1300
Ortho instrument



786-1301
Ortho light Band Pusher Scaler

ORTHODONTIC INSTRUMENTS

■ Инструменты ортодонтические
 ■ Instrumentos Ortodonticos
 ■ Orthodontische Instrumente

■ Інструменти ортодонтичні
 ■ Instruments Orthodontiques
 ■ أدوات تقويم الأسنان

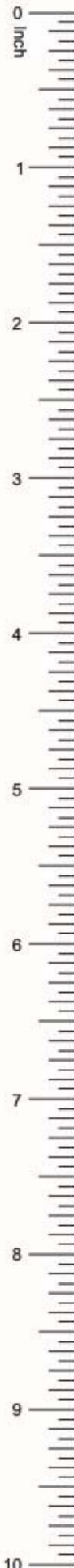

786-1302
 Ortho Light double ended
 ligature director



786-1303
 Ortho Light double ended
 ligature scaler



786-1304
 Ortho Light double ended ligature scaler director tivate coil spring
 are remove modules with one instruments



786-1305
 Ortho band pusher scaler



786-1306
 Ortho Light Band Pusher scaler



786-1307
 Ortho Ligature director single ended



786-1308
 Ortho Light double ended ligature director scaler



786-1309
 Ortho Light double ended ligature scaler director
 tivate coil spring are remove modules with one instruments



786-1310
 Ortho Light double ended ligature director



786-1311
 Ortho Light ligature director scaler



786-1312
 Ortho Light ligature director double ended



786-1313
 Double ended cement spatula



786-1314
 Ortho Light scaler single ended

PLIERS FOR ORTHODONTICS & PROSTHETICS

- Щипцы для ортодонтии и протезирования
- Pincers pour l'orthodontie et la prothèse
- Zanger für Kieferorthopädie und Prothetik

- Щипці для ортодонції та протезування
- Alicates para ortodoncia y prótesis
- كماشة لتقويم الأسنان بروتستيس

BOX JOINT PLIERS

786-1315
Universal Dolphin Style
Wire Bending & cutting pliers



786-1316 Band Removing Plier
This curved blade of the band removing plier can strip easily and gently remove directly to the tooth, Length 130mm



786-1317
Tweed Loop forming Pliers



786-1318 How Plier Curved
Universal usable tool for the multiband technology for wires up to .028" Length 130mm



786-1319 How Plier
Universal usable tool for the multiband technology for wires up to .028" Length 135mm



786-1320
Nance Loop forming Pliers



786-1321
Bracket Removing Plier curved
Bracket Removing curved for easy removal of brackets in the posterior region. Length 130mm



786-1322
Young Wire Bending & Loop Forming Pliers



786-1323
Wire Bending & Loop Forming Pliers



786-1324
Adams, small wire bending and loop forming Pliers



786-1325
Bracket Removing Plier Round Box
Bracket removing plier for comfortable and quick remover of the brackets. Length 135mm



786-1326
Weingart Plier medium
Weingart plier that are ideal due to their curved tip for setting sheets and is capable of bending the ends Length 145mm



PLIERS FOR ORTHODONTICS & PROSTHETICS

- Щипцы для ортодонтии и протезирования
- Pincès pour l'orthodontie et la prothèse
- Zanger für Kieferorthopadie und Prothetik

- Щипці для ортодонції та протезування
- Alicates para ortodoncia y prótesis
- کماشة لتقويم الأسنان بروتستیتیس

BOX JOINT PLIERS

786-1327

Adams Plier Round Box

Adams pliers for bending wire arches and bends right angles for wires up to .022", .025 tip to beak Length 125mm



786-1333 Adams Plier

Adams pliers for bending wire arches and bends right angles for wires up to .022", .025 tip to beak Length 125mm



786-1328

Falcon Beak Contouring Pliers



786-1334 Tweed

Loop Forming Pliers



786-1329

Wires up to 0.020" / 0.7mm



786-1335 Bird Beak Plier Standard

Bird Beak Wire bending plier without notches, which is suitable as a universal utility too Length 125mm



786-1330

Johnson Contouring Pliers



786-1336

Mini Ligature cutters



786-1331 Aderer

Large wire bending and loop forming pliers



786-1337 Small Fluch-cut distal and cutting Pliers

with safety hold fitted with un-breakable, corrosion resistant and durable stainless steel tips



786-1332 Tweed

Angle rectangular arch forming & Torquing pliers



786-1338 Large Fluch-cut distal and cutting Pliers

with safety hold fitted with un-breakable, corrosion resistant and durable stainless steel tips



PLIERS FOR ORTHODONTICS & PROSTHETICS

■ Щипцы для ортодонтии и протезирования
 ■ Pincers pour l'orthodontie et la prothèse
 ■ Zanger für Kieferorthopädie und Prothetik

■ Щипці для ортодонції та протезування
 ■ Alicates para ortodoncia y prótesis
 ■ كاشاة لتقويم الأسنان وبروسهتیس

BOX JOINT PLIERS

786-1339

Tweed / Angle

1.78mm (.070") wide tips arch forming and torquing pliers



786-1345 **Large**

Contouring Plier



786-1340

Tweed / Angle

1.78mm (.070") wide tips arch forming and torquing pliers



786-1346

Bands & Crowns Plier

In order to skirt



786-1341

Lingual / Palatal arch

forming pliers



786-1347

Ligature Forming Pliers



786-1342

Aderer

Facebow loop forming plier



786-1348

For double back and triple back bands in 0.30" / 0.7mm & 0.36 / 0.91mm lingual arch wires



786-1343

Waldsavhs wire bending and cutting pliers



786-1349

Bird Beak Wire Bending & cutting pliers



786-1344 **Aderer Plier**

For the manufacturing of appliances and activation of wires for wires up to .030" fine tip and up to .036" mean tip Length 130mm



786-1350

Weingart Plier Medium

Weingart plier that are ideal due to their curved tip for setting sheets and is capable of bending the ends. Length 145mm



PLIERS FOR ORTHODONTICS & PROSTHETICS

- Щипцы для ортодонтии и протезирования
- Pincers pour l'orthodontie et la prothèse
- Zanger für Kieferorthopadie und Prothetik
- Щипці для ортодонції та протезування
- Alicates para ortodoncia y prótesis
- كاشاة لتقويم الأسنان وبروسيثيس

L-KEY JOINT PLIERS



786-1351
Distal end cutter with safety hold mini head, long handles, fitted with un-breakable, corrosion resistant and durable stainless steel tips

- 0.30 mm to 0.50 mm (0.12" to .020")
- Max. 0.40 mm to 0.64 mm (0.18" x .025")
- ⊗ 0.38 mm to 0.53 mm (0.155" to .0215")
- ⊗ Max. 0.53 mm to 0.64 mm (0.21" x .025")



786-1352
Flush-cut distal end cutter with safety hold fitted with un-breakable, corrosion resistant and durable stainless steel tips

- 0.30 mm to 0.50 mm (0.12" to .020")
- Max. 0.46 mm to 0.64 mm (0.18" x .025")



786-1353
Soft wire and ligature cutter Mini fitted with un-breakable corrosion resistant and durable stainless steel tips

- ⌞ .25 mm to .38 mm (.010" to .015")



786-1354
Soft wire and ligature cutter, standard fitted with un-breakable corrosion resistant and durable stainless steel tips

- ⌞ .25 mm to .38 mm (.010" to .015")



786-1355
Soft wire and ligature cutter 15° angled fitted with un-breakable corrosion resistant and durable stainless steel tips

- ⌞ .25 mm to .38 mm (.010" to .015")



786-1356
Soft wire and ligature cutter 45° angled fitted with un-breakable corrosion resistant and durable stainless steel tips

- ⌞ .25 mm to .38 mm (.010" to .015")



786-1357
Hard wire cutter, straight fitted with un-breakable, corrosion resistant and durable stainless steel tips

- 0.30 mm to 0.50 mm (0.12" to .020")
- Max. 0.56 mm to 0.71 mm (0.22" x .028")



786-1358
Hard wire cutter, 15° angled fitted with un-breakable, corrosion resistant and durable stainless steel tips

- 0.30 mm to 0.50 mm (0.12" to .020")
- Max. 0.56 mm to 0.71 mm (0.22" x .028")



786-1359
Hard wire cutter, 15° angled Non-autocleavable

- 0.30 mm to 0.50 mm (0.12" to .020")
- Max. 0.56 mm to 0.71 mm (0.22" x .028")



PLIERS FOR ORTHODONTICS & PROSTHETICS

■ Щипцы для ортодонтии и протезирования
 ■ Pincers pour l'orthodontie et la prothèse
 ■ Zanger für Kieferorthopädie und Prothetik

■ Щипці для ортодонтії та протезування
 ■ Alicates para ortodoncia y prótesis
 ■ كماشة لتقويم الأسنان برومشتیتیس

L-KEY JOINT PLIERS



786-1360
Band removing pliers



786-1365
Weingart-mini
Utility Pliers

● 0.30 mm to 0.50 mm (0.12" to .020")
 ■ Max. 0.56 mm to 0.71 mm (0.22" x .028")



786-1361
Bracket removing
Pliers angled



786-1366
Weingart-mini
Utility Pliers

● 0.30 mm to 0.50 mm (0.12" to .020")
 ■ Max. 0.56 mm to 0.71 mm (0.22" x .028")



786-1362
Bracket removing pliers straight



786-1367
How Straight
Utility Pliers

● 0.30 mm to 0.50 mm (0.12" to .020")
 ■ Max. 0.56 mm to 0.71 mm (0.22" x .028")

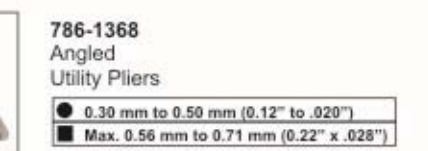

786-1363
Bracket removing pliers with plastic tip



786-1368
Angled
Utility Pliers

● 0.30 mm to 0.50 mm (0.12" to .020")
 ■ Max. 0.56 mm to 0.71 mm (0.22" x .028")



786-1364
Adhesive removing pliers



786-1369
Wire bending and loop forming pliers
Angled (Bird Beak)

● 0.30 mm to 0.50 mm (0.12" to .020")
 ■ Max. 0.56 mm to 0.71 mm (0.22" x .028")

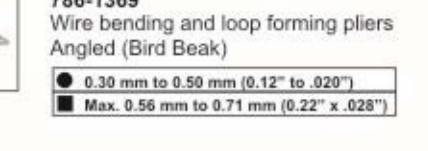

PLIERS FOR ORTHODONTICS & PROSTHETICS

- Щипцы для ортодонтии и протезирования
- Pincers pour l'orthodontie et la prothèse
- Zanger für Kieferorthopadie und Prothetik
- Щипці для ортодонції та протезування
- Alicates para ortodoncia y prótesis
- كاشاة للتقويم الأسنان وبروسثيتيس

L-KEY JOINT PLIERS



786-1370
Multi-purpose pliers, bird beak
De la rosa and cutter in one

● 0.30 mm to 0.50 mm (0.12" to .020")
■ Max. 0.46 mm to 0.56 mm (0.18" x .022")



786-1375
Stop pliers V-Bebd - 1mm

● 0.30 mm to 0.50 mm (0.12" to .020")
■ Max. 0.56 mm to 0.71 mm (0.22" x .028")



786-1371
Cinch Back / the back
Distal end bending pliers

● 0.30 mm to 0.50 mm (0.12" to .020")
■ Max. 0.56 mm to 0.71 mm (0.22" x .028")



786-1376
Lingual / palatal arch forming pliers

● 0.30 mm to 0.50 mm (0.12" to .020")
■ Max. 0.56 mm to 0.71 mm (0.22" x .028")



786-1372
Hammer head
Distal end bending pliers

● 0.30 mm to 0.50 mm (0.12" to .020")
■ Max. 0.56 mm to 0.71 mm (0.22" x .028")



786-1377
Torquing pliers set



786-1373
Nance Loop forming pliers

● 0.36 mm to 0.71 mm (0.14" to .028")
■ Max. 0.56 mm to 0.70 mm (0.22" x .028")



786-1378
Tweed / angled
Rectangular arch forming and
torquing pliers

● 0.30 mm to 0.71 mm (0.12" to .020")
■ Max. 0.56 mm to 0.71 mm (0.22" x .028")



786-1374
Detailing step pliers / Bayonet
bending pliers - 1mm

● 0.30 mm to 0.50 mm (0.12" to .020")
■ Max. 0.56 mm to 0.71 mm (0.22" x .028")



786-1379
Surgical ball hook crimping pliers
angled



786-1380
Surgical ball hook crimping pliers
straight



PLIERS FOR ORTHODONTICS & PROSTHETICS

■ Щипцы для ортодонтии и протезирования
 ■ Pincettes pour l'orthodontie et la prothèse
 ■ Zanger für Kieferorthopädie und Prothetik

■ Щипці для ортодонції та протезування
 ■ Alicates para ortodoncia y prótesis
 ■ كاشاة لتقويم الأسنان بروسشیتیس

L-KEY JOINT PLIERS



786-1381
 Aderer Clamp three jaw wire bending plier for contouring and bending wire up to 30° / 0.76mm



786-1387
 Falcon beak contouring pliers

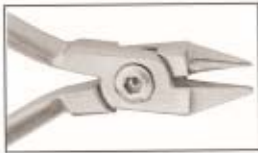

786-1382
 Bird beak plier for bending round square and rectangle wire up to 30° / .76mm

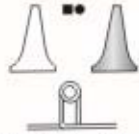

786-1388
 For placement and removal of arch wires, pins and other auxiliaries



786-1383
 Bird beak plier for light wire bending round square and rectangular up to .016" / 0.41mm

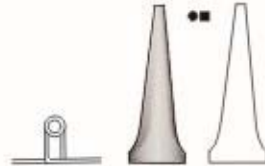

786-1389
 For placement and removal of arch wires, pins and other auxiliaries in angle design



786-1384
 Double Rounded jaw bending pliers hooks and wire up to .020" / 0.51mm

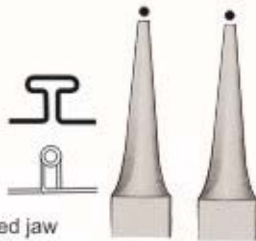

786-1390
 Contouring Plier



786-1385
 Adams pliers to hooks and bending wire up to .030" / 0.76mm

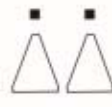

786-1391
 Bending plier, in order to skirt molaras bands, with grooved Recommended wire .016", .018" and .022" .041mm, 0.46mm and 0.56mm



786-1392
 Long forming in four length 3,4,5, 7 6mm wire capacity 0.22 . 56mm

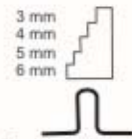

786-1386
 Johnson pliers for crown band contouring



786-1393
 Arch bending plier design for convenient handling of square or rectangular wire, 0.20" / 0.51mm



PLIERS FOR ORTHODONTICS & PROSTHETICS

- Щипцы для ортодонтии и протезирования
- Pincers pour l'orthodontie et la prothèse
- Zanger für Kieferorthopadie und Prothetik

- Щипці для ортодонції та протезування
- Alicates para ortodoncia y prótesis
- كاشاة لتكوير الأسنان بروتستياتيس

LAP & L-KEY JOINT PLIERS

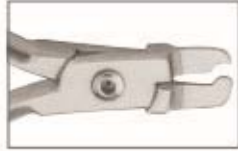

786-1394
In order to skirt
bands and crowns.



786-1395
Wires up to
.020" / 0.7mm

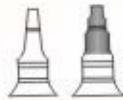

786-1396
Round and concave plier
for loop forming and bending
wire up to .20" / .051mm



786-1397
Bending for round square
or rectangular wire up
to 0.30" / 0.76mm

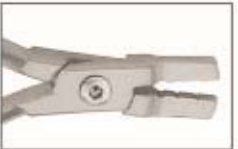

786-1398
for double back and triple
back bands in 0.30" / .76mm
& .036" / 91mm lingual arch wires



786-1399
Detailing step plier double sided
offset beak permits bayonet bends.
Creates right hand or left hand
step-up or stepdown at 1/2", 3/4" or
1mm increments.

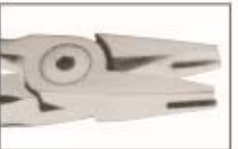

786-1400
"V" bend stop special design makes
1mm "V" bends to shorten archwires
or provide a positive stop Excellent
for placing stop in nitanium wires
For round of rectangular wires up to .025"



786-1401
Angle how plier efficient utility plier
with serrated beak for a firm grip
45 angled tips to access hand or
reach areas.



786-1402
Weingardt plier serrated tips hold
wires firmly at a convenient working
angle tapered beak fit easily
between brackets and hard to reach
areas, Our most popular utility plier



786-1415
Pin 8 Ligature Cutter
TC



786-1416
Mini Pin 8 Ligature
Cutter TC



786-1417
Standard Ligature
Cutter TC



786-1418
V Band Stop Plier
TC.



786-1419
Angled Direct Bond Bracket
Remover TC



DISTAL END, WIRE CUTTER & BRACKET REMOVER PLIERS

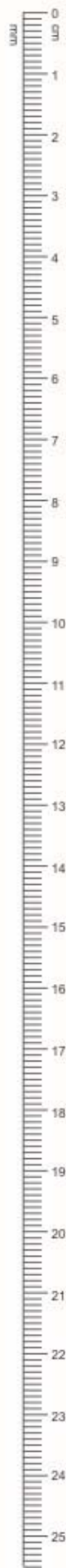

786-1420
Distal end Cutter Safety hold Plier
(Ideal for Cutting Wire) TC



786-1421
Hook Crimping Plier Angled
Straight TC



786-1422
3 Prong Clasp Adjustable
Plier TC



786-1423
Utility Plier Weingart TC



786-1424
Diret Bracket Remover
TC



786-1425
Straight Direct Bond Bracket
Remover TC



786-1426
Pin Holding Plier TC



786-1427
Hard wire cutter



786-1428
Elastic Separating Plier
Round Handle



786-1429
Elastic Separating Plier



786-1430
786-1431
Smaha
Elastomeric
ligature
placing forceps
140mm



786-1432
Elastomeric
ligature placing
forceps with
groove
Falcon 140mm



786-1433
Elastomeric
ligature placing
forceps with
groove
Falcon 140mm





Normal Anatomy – Dental Implants

Bone Level Normal
(No Bone Loss)

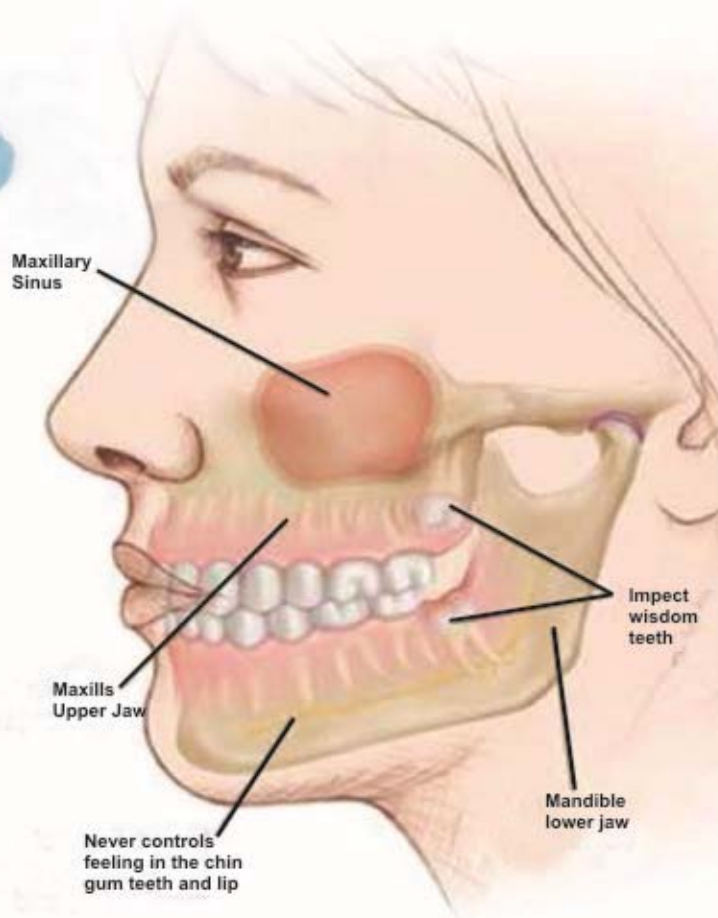
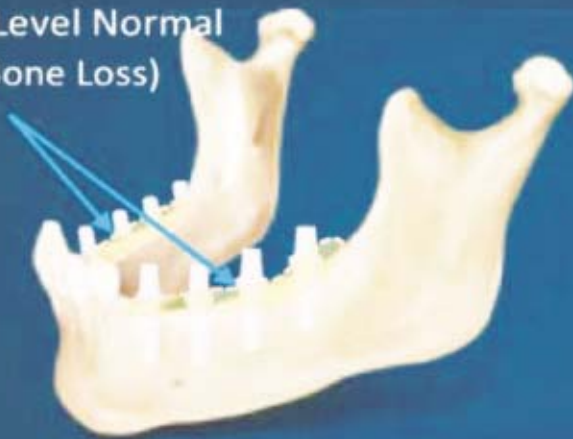

■ Инструменты для имплантологии
 ■ Implantologie
 ■ Implantologie

■ Инструменти для імплантології
 ■ Implantologia
 ■ زراعة الأسنان

IMPLANT GAGES



786-1434
Multifunctional Meter
 Length 90 mm
 different sizes,
 8-10-11mm,
 corrosion-resistant

786-1435
Multifunctional Meter
 Length 90 mm
 different sizes,
 5-13-15-17mm,
 corrosion-resistant

786-1436
Measuring Probe
 Length 170 mm
 hand shape or flexible
 (6-8-10-14-16 mm)
 corrosion-resistant

786-1437

786-1438

786-1439 786-1440

IMPLANT GAGES



786-1441

786-1442

786-1443

IMPLANTOLOGY

■ Инструменты для имплантологии
 ■ Implantologie
 ■ Implantologie

■ Инструменти для імплантології
 ■ Implantologia
 ■ زراعة الأسنان



786-1444
Clamp, Osteometer
 Length about 155 mm
 ridge width measurement
 two sided scale
 measuring
 range 0-25 mm



786-1445
Measuring Loop
 straight length 90 mm
 measuring range
 0-40 mm



786-1446
Measuring Loop
 angled length 90 mm
 measuring range
 0-40 mm



786-1447
Measuring Loop Castroviejo
 angled length 175 mm
 measuring range 0-40 mm
 with window



786-1448
Boley Gauge
 Stainless Steel



786-1449
Measuring Loop
 angled length
 175 mm
 measuring range
 0-40 mm



786-1450
Measuring Loop
 straight length
 175 mm
 measuring range
 0-40 mm



786-1451
Fig,1
 Iwanson
 spring caliper
 For metal and
 porcelain



786-1452
Fig, 2
 Iwanson
 spring caliper
 For wax



786-1453
Bone Thickness Gauge
 40mm, 180mm



786-1454
Gauge
 for measuring
 distances
 (0.90 mm)

■ Инструменты для имплантологии
 ■ Implantologie
 ■ Implantologie

■ Инструменти для імплантології
 ■ Implantologia
 ■ زراعة الأسنان

BLACK TITANIUM COLOUR COATED INSTRUMENTS

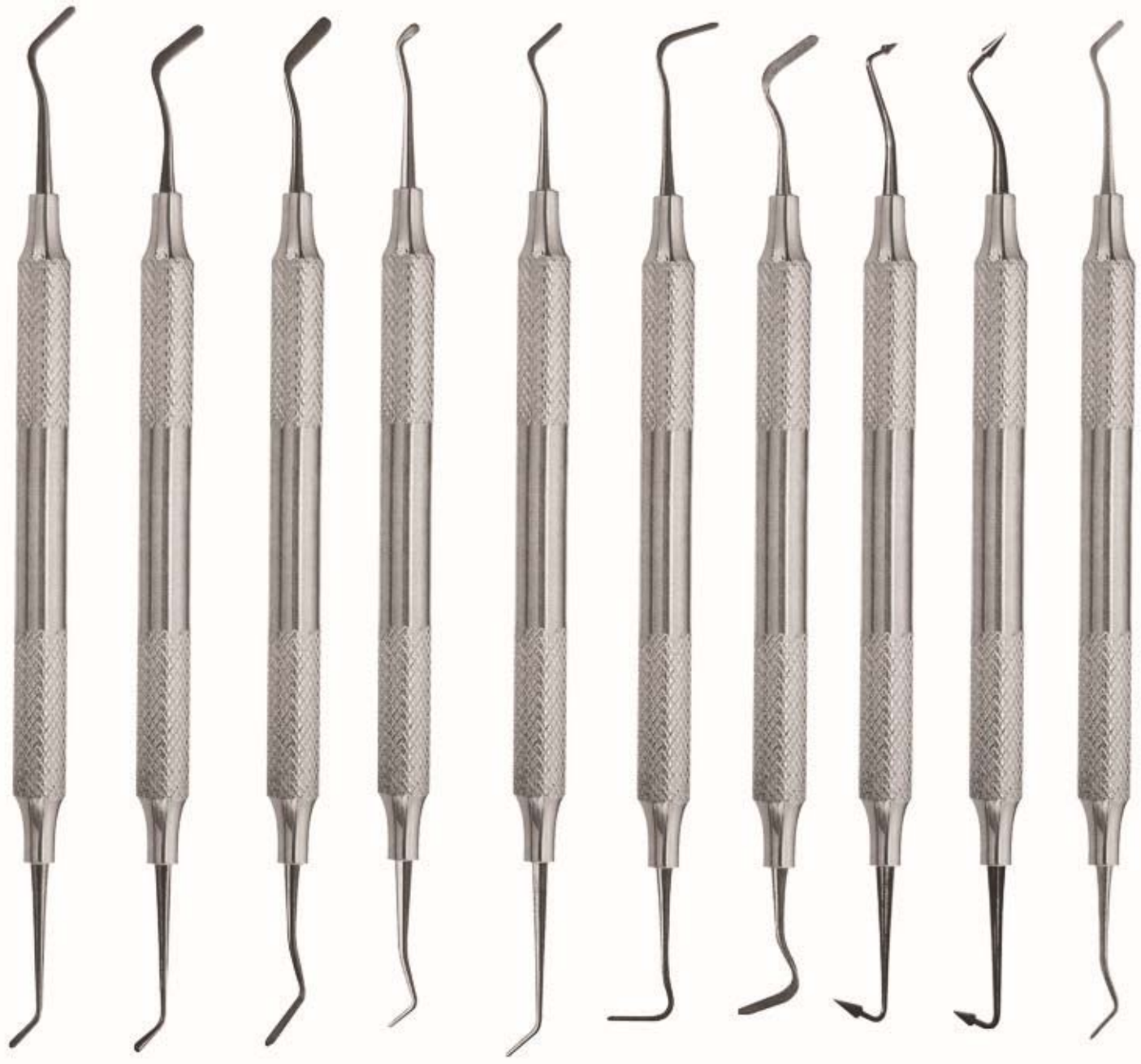

786-1455
#1

786-1456
#2

786-1457
#3
Extra-Flex

786-1458
Micro-Mini

786-1459
Mini 1

786-1460
Mini 4
Extra-Flex

786-1461
#4
Extra-Flex

786-1462
#5
Flexi-Thin

786-1463
#6
Flexi-Thin

786-1464
Mini 3
Extra-Flex

IMPLANTOLOGY

■ Инструменты для имплантологии
■ Implantologie
■ Implantologie

■ Инструменти для імплантології
■ Implantoloia
■ زراعة الأسنان

BLACK TITANIUM COLOUR COATED INSTRUMENTS

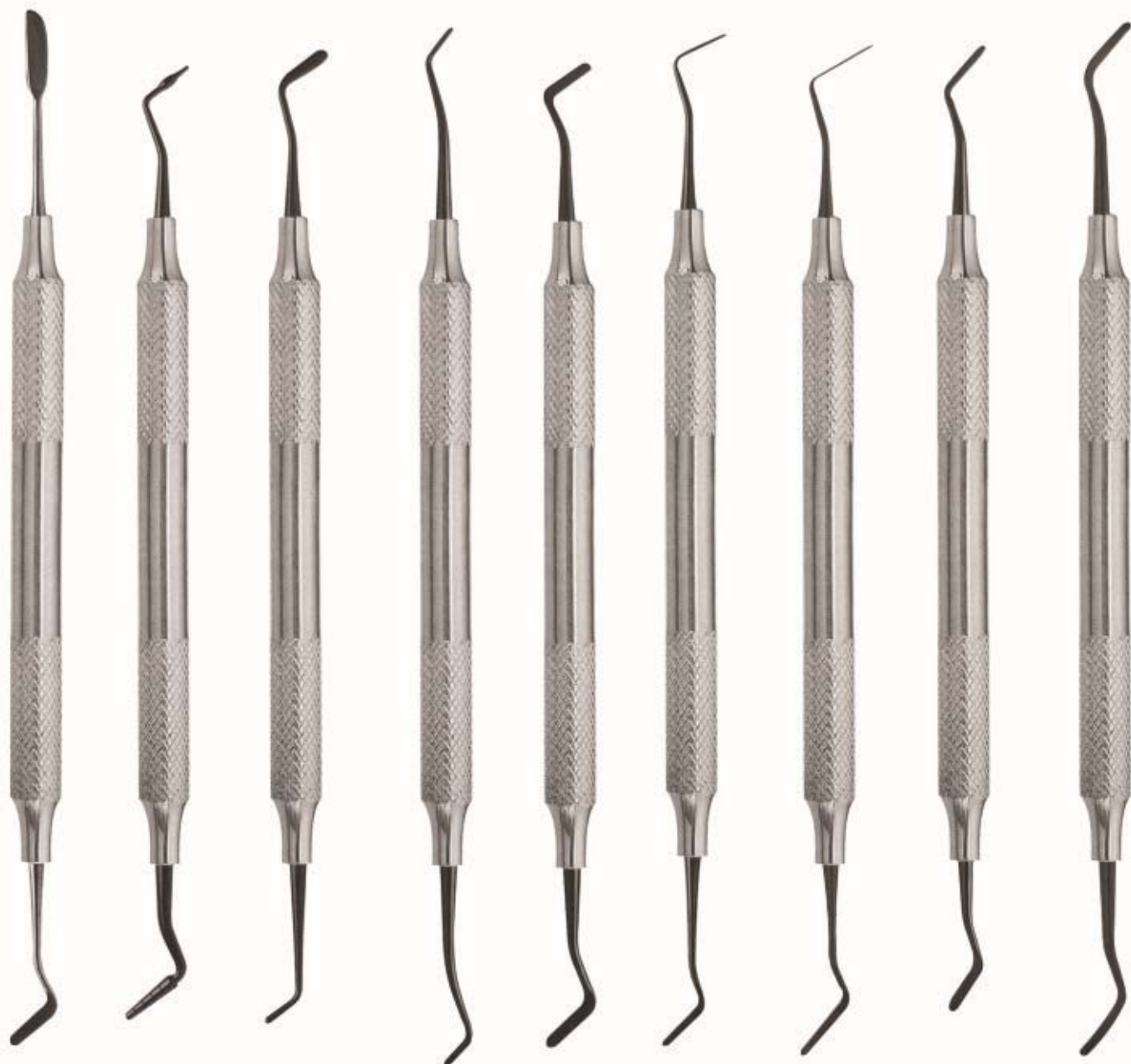

786-1465
AB1
Boghosian

786-1466
AB2
Boghosian

786-1467
W3

786-1468
8A

786-1469
4/5
Gregg

786-1470
Interproximal
Carver

786-1471
Interproximal
Carver, Longe

786-1472
A6

786-1473
Contouring
Instrument

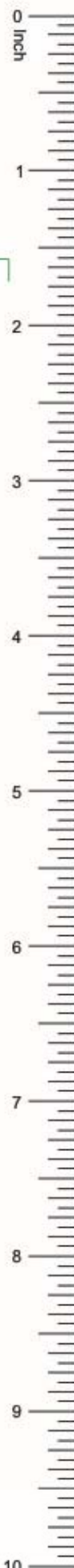

■ Инструменты для имплантологии
 ■ Implantologie
 ■ Implantologie

■ Инструменти для имплантології
 ■ Implantoloia
 ■ زراعة الأسنان

BLACK TITANIUM COLOUR COATED INSTRUMENTS

BURNISHERS

FREEDMAN BURNISHERS



786-1474
21B



786-1475
27/29



786-1476
2
Ladmore



786-1477
3
Ladmore



786-1478
Freedman
"Duckhead"



786-1479
Freedman
Small Contact
Forming



786-1480
Freedman
Large Contact
Forming



786-1481
Small/
Medium Ball
Burnisher

IMPLANTOLOGY

■ Инструменты для имплантологии
■ Implantologie
■ Implantologie

■ Инструменти для імплантології
■ Implantologia
■ زراعة الأسنان

BLACK TITANIUM COLOUR COATED INSTRUMENTS

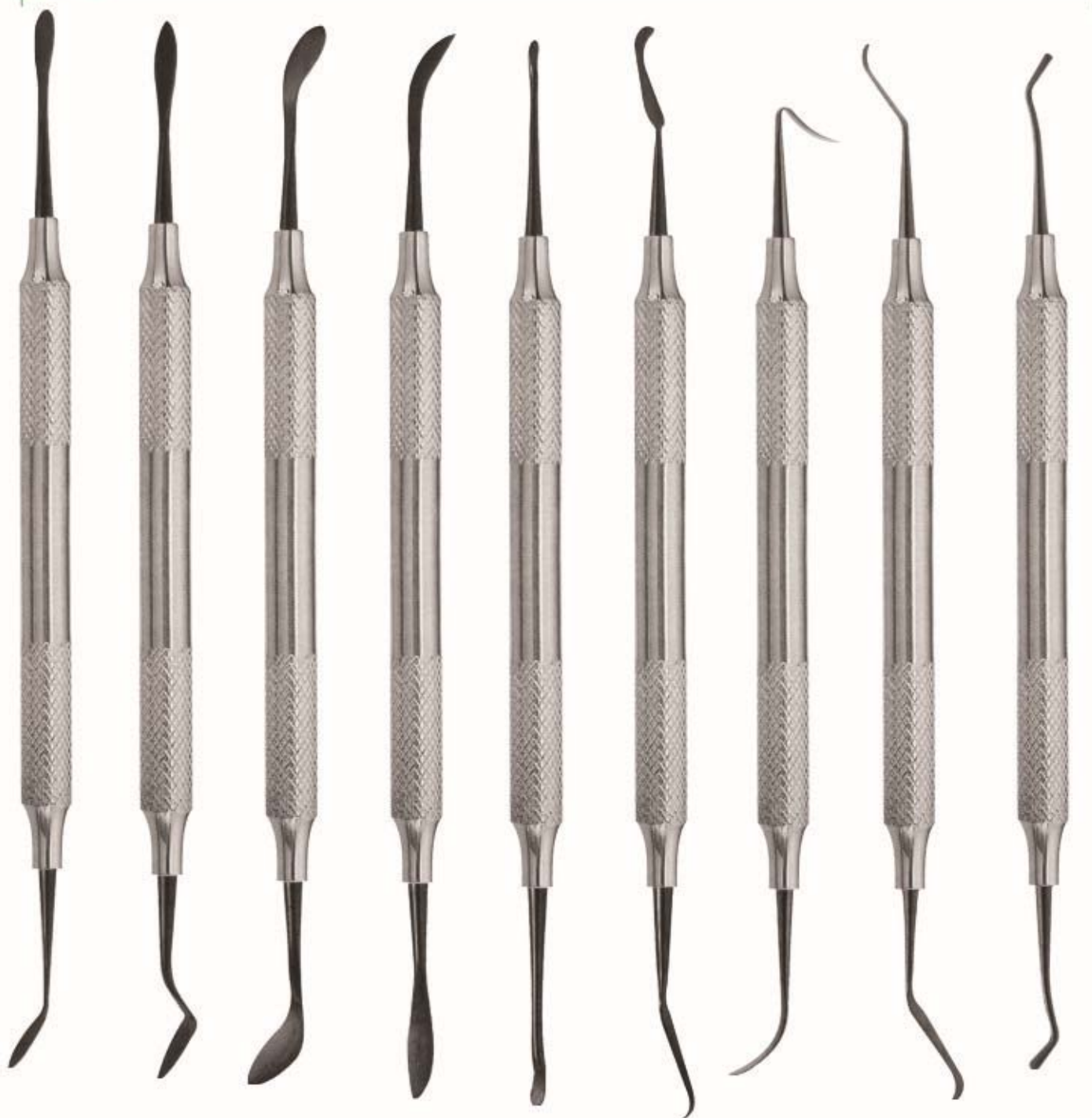

786-1482
A
Cosmetic
Contouring

786-1483
B
Cosmetic
Contouring

786-1484
C
Cosmetic
Contouring

786-1485
D
Cosmetic
Contouring

786-1486
E
Cosmetic
Contouring

786-1487
F
Cosmetic
Contouring

786-1488
Marginal Ridge
& Embrasure
Shaping Inst

786-1489
Occlusal
Anatomy
Instrument

786-1490
Composite
Packing
Instrument

■ Инструменты для имплантологии
 ■ Implantologie
 ■ Implantologie

■ Инструменти для імплантології
 ■ Implantologia
 ■ زراعة الأسنان

BLACK TITANIUM COLOUR COATED INSTRUMENTS

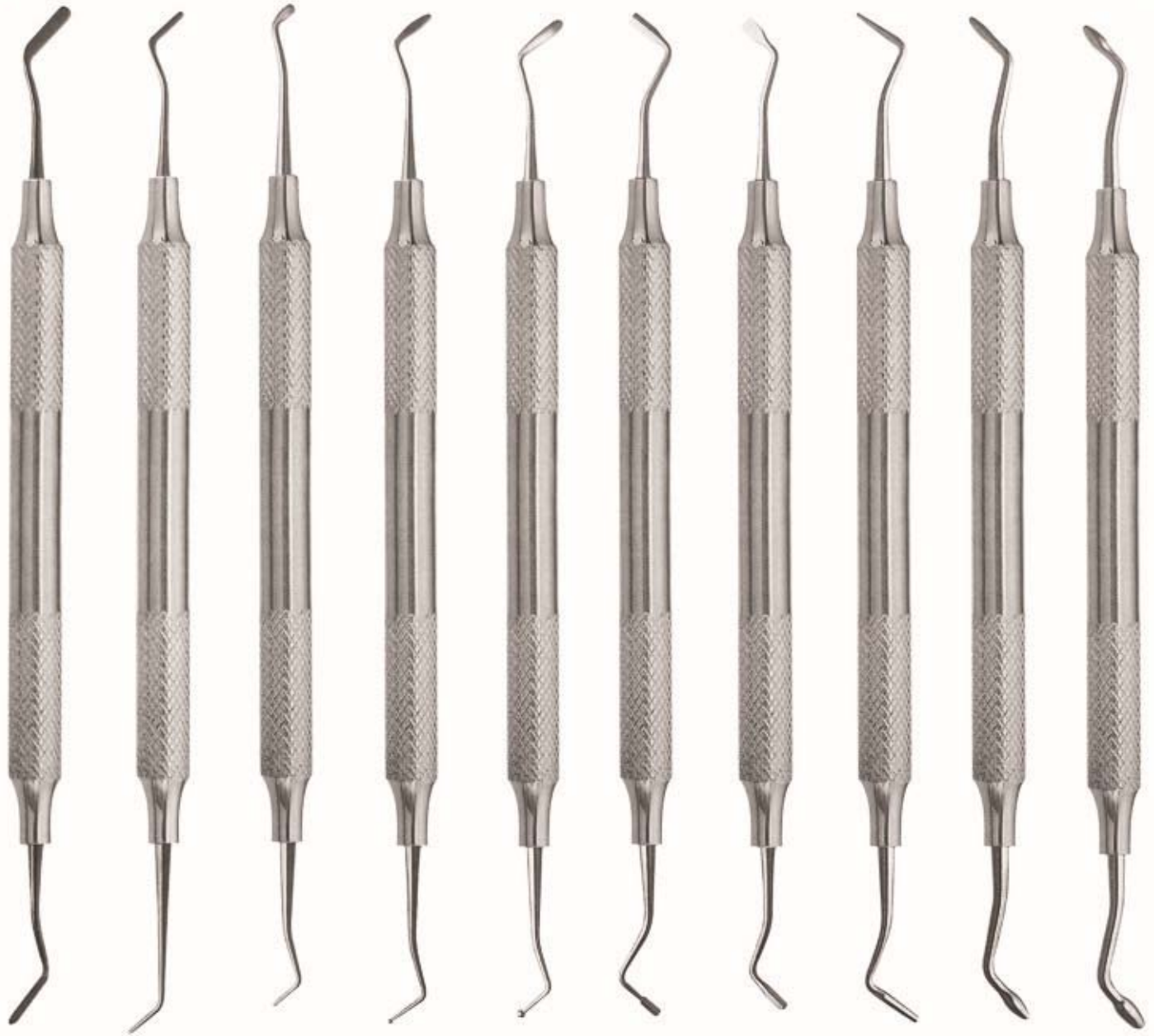

786-1491
 #3
 Extra-Flex

786-1492
 Mini 1

786-1493
 Micro-Mini

786-1494
 Medium
 Placing/
 Condensing

786-1495
 Large
 Placing/
 Condensing

786-1496
 OT
 Tanner

786-1497
 3
 Hollenback

786-1498
 5A

786-1499
 Small/Medium
 Contact
 Forming

786-1500
 Medium/Large
 Contact
 Forming

IMPLANTOLOGY

■ Инструменты для имплантологии
■ Implantologie
■ Implantologie

■ Инструменти для імплантології
■ Implantologia
■ زراعة الأسنان

SINUS LIFT INSTRUMENTS HOLLOW HANDLE 9.5MM LENGTH 170MM

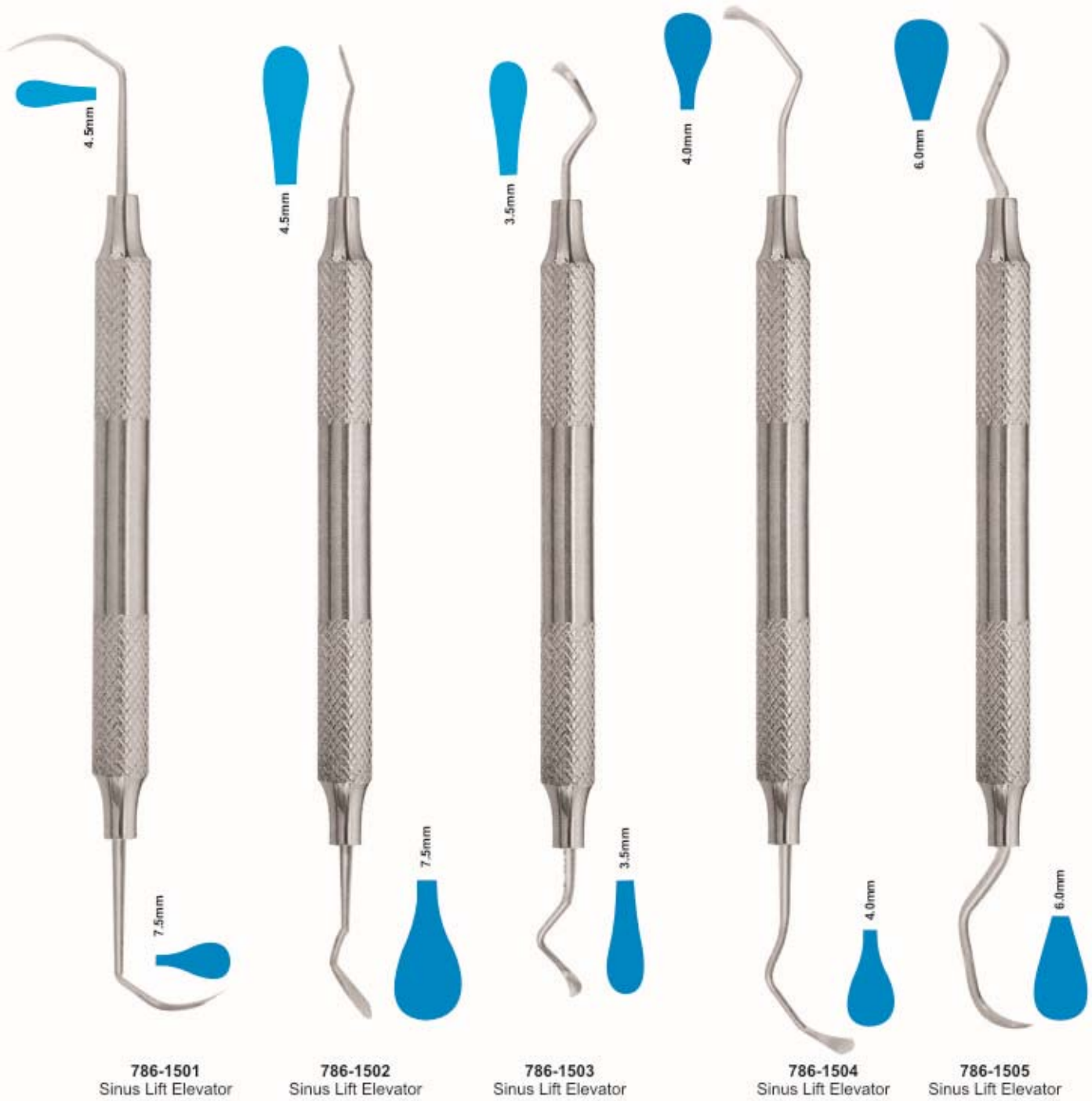

■ Инструменты для имплантологии
■ Implantologie
■ Implantologie

■ Инструменти для імплантології
■ Implantologia
■ زراعة الأسنان

SINUS LIFT INSTRUMENTS HOLLOW HANDLE 9.5MM LENGTH 170MM



786-1506
Sinus Lift Elevator



786-1507
Sinus Lift Elevator



786-1508
Sinus Lift Elevator



786-1509
Sinus Lift Elevator

IMPLANTOLOGY

■ Инструменты для имплантологии
■ Implantologie
■ Implantologie

■ Инструменти для имплантології
■ Implantoloia
■ راعة الأسنان

IMPLANT SINUS LIFT INSTRUMENTD HOLLOW HANDLE 9.5MM LENGHT 170MM

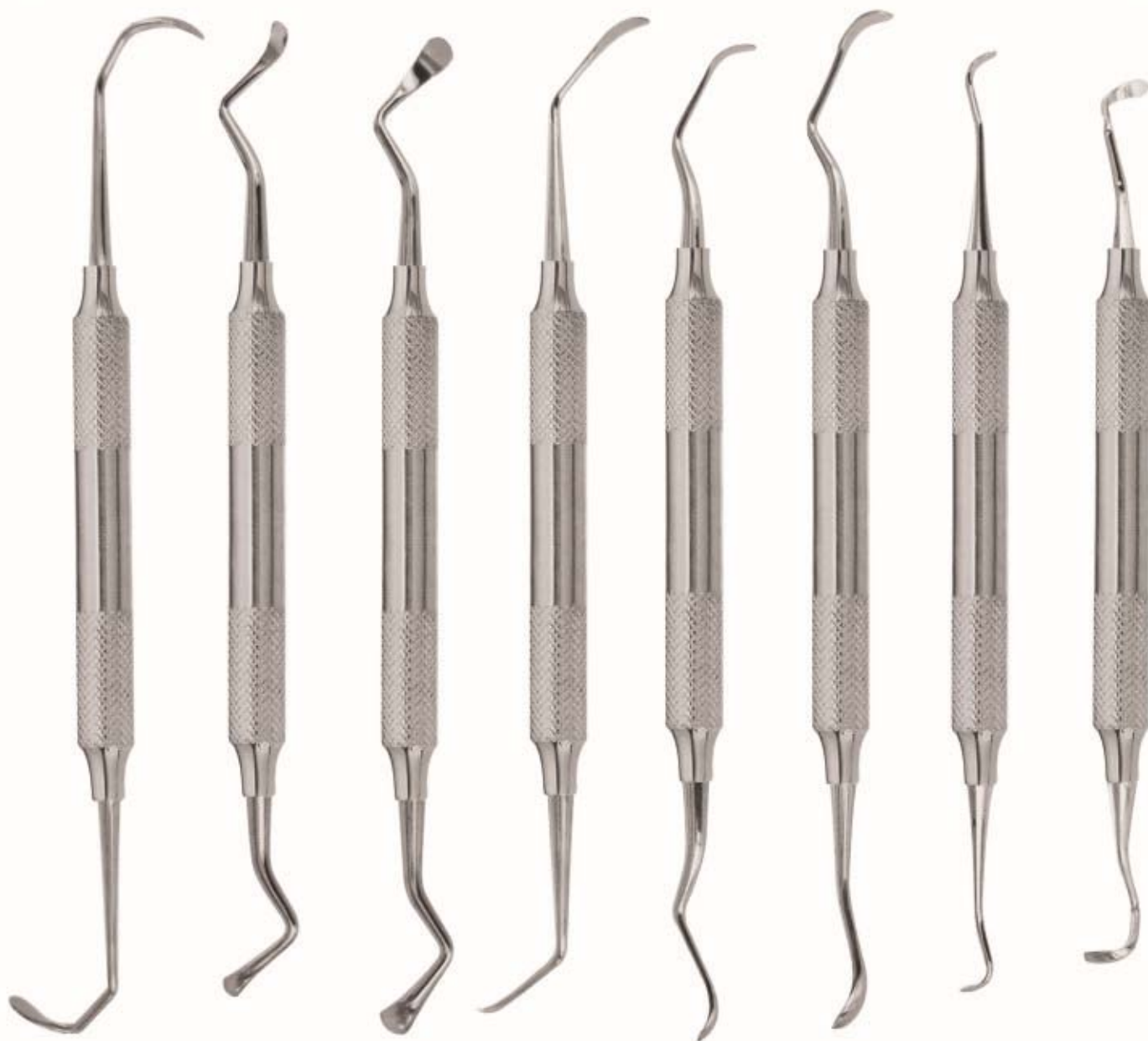

786-1510
Acute 6577

786-1511
Sinus 1

786-1512
Sinus 2

786-1513
Sinus 3
Obtuse 6578

786-1514
Sinus 4

786-1515
Sinus 5

786-1516
Sinus 6

786-1517
Sinus 7

IMPLANTOLOGY

■ Инструменты для имплантологии
■ Implantologie
■ Implantologie

■ Инструменти для імплантології
■ Implantologia
■ زراعة الأسنان

SINUS LIFT INSTRUMENTS HOLLOW HANDLE 9.5MM LENGTH 170MM

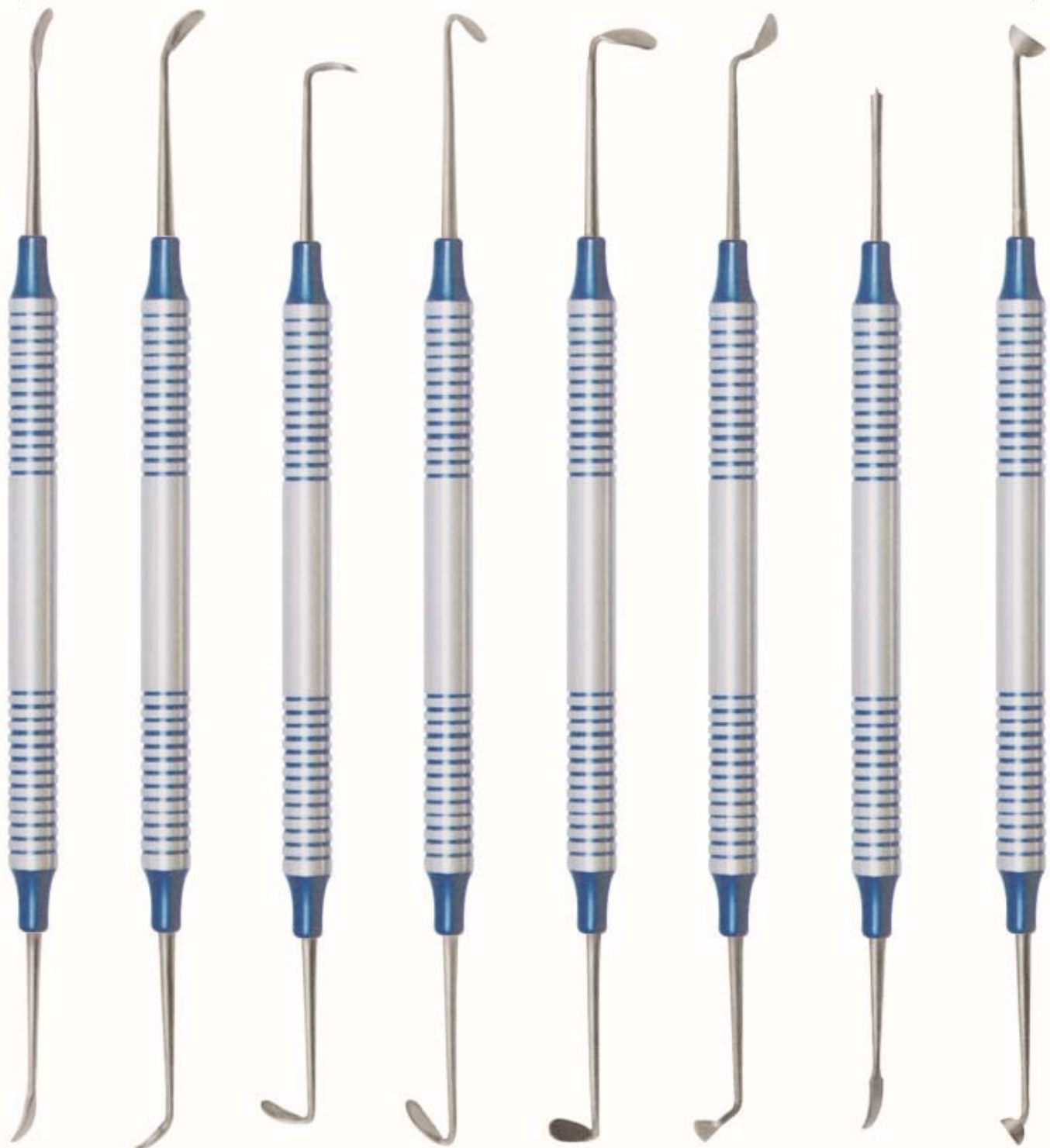

786-1518
Sinus Lift 1

786-1519
Sinus Lift 2

786-1520
Sinus Lift 3

786-1521
Sinus Lift 4

786-1522
Sinus Lift 5

786-1523
Sinus Lift 6

786-1524
Membrane
3Positioning

786-1525
Condenser 1

IMPLANTOLOGY

- Инструменты для имплантологии
- Implantologie
- Implantologia

- Инструменти для імплантології
- Implantoloia
- زراعة الأسنان

Sinus Lift Instruments

Flexible Sinus Lift instruments reduce the risk of perforation of the "Schneider's membrane"

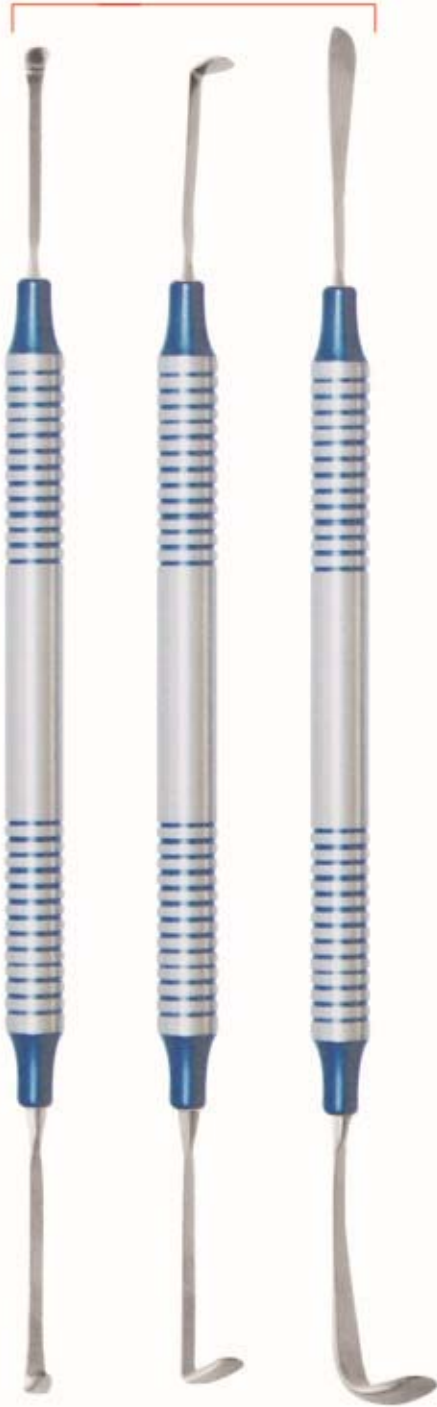

786-1526
Fig. 1

786-1527
Fig. 2

786-1528
Fig. 3

Sinus Lift Elevator

10 mm Straight grip
Length 175 mm, Sinus lift elevators, dull for gentle peeling and lifting the "Schneider's membrane"



786-1529
Fig. 1

786-1530
Fig. 2

786-1531
Fig. 3

Sinus Lift Instrument

10 mm Straight grip Length 180 mm, Buser (B1, B2, B3) raspations, quality medical stainless steel, corrosion-resistant



786-1532
B01

786-1533
B02

786-1534
Fig. B03



IMPLANTOLOGY

■ Инструменты для имплантологии
■ Implantologie
■ Implantologie

■ Инструменти для імплантології
■ Implantologia
■ زراعة الأسنان

Sinus Lift Instrument 10 mm Striaght grip Sinus lift elevators, blunt or sharply curved (H01, H02, K03, K04, K78, K77)

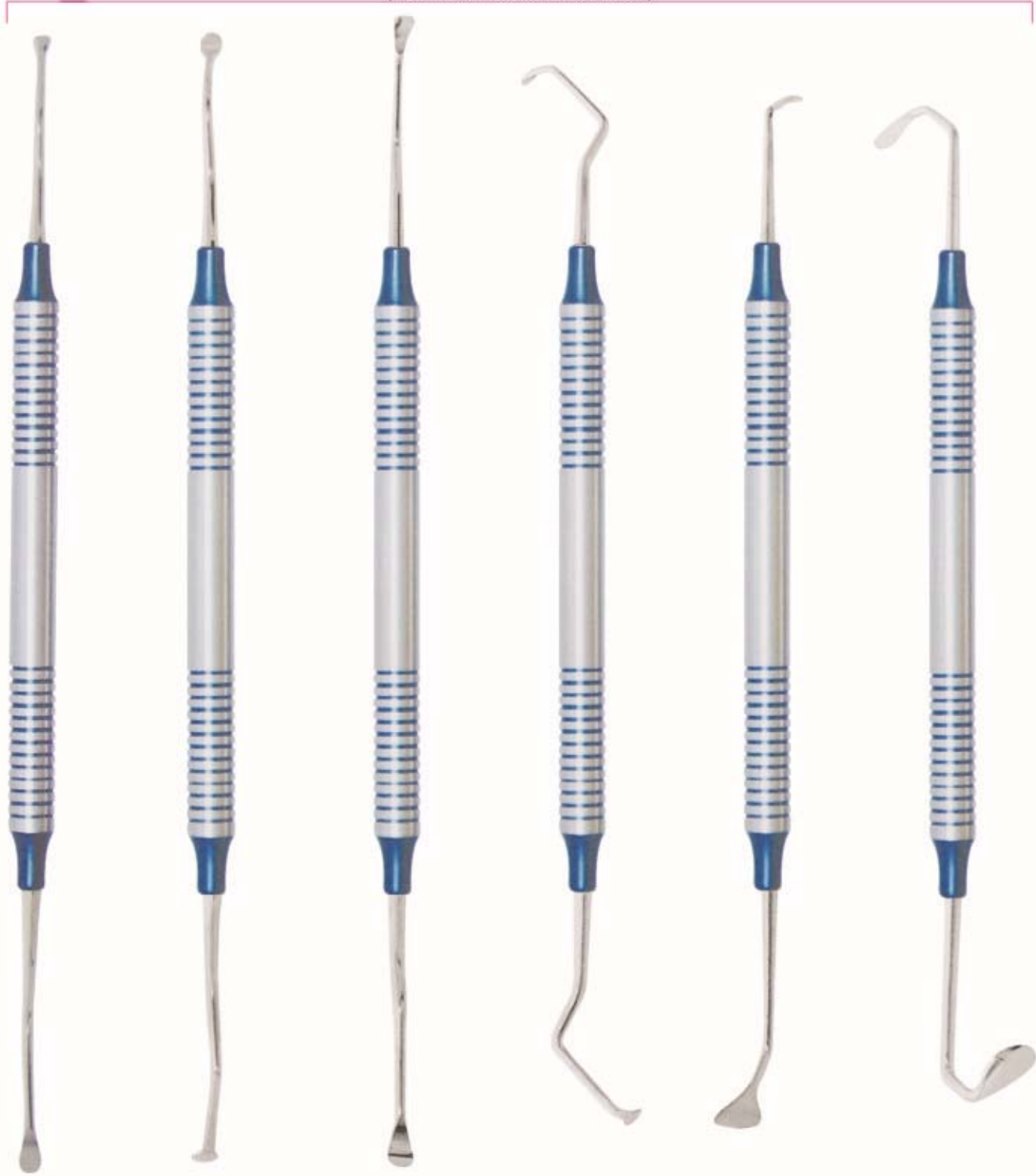

786-1535
Sinus lift instrument
H01

786-1536
Sinus lift instrument
H02

786-1537
Sinus lift instrument
K03

786-1538
Sinus lift
instrument
K04

786-1539
Sinus lift
instrument
K78

786-1540
Sinus lift
instrument
K77

IMPLANTOLOGY

■ Инструменты для имплантологии
■ Implantologie
■ Implantologie

■ Инструменти для імплантології
■ Implantologia
■ زراعة الأسنان

SINUS LIFT INSTRUMENTS

Sinus Lift Elevators, 10 mm Hollow Handle Length 170mm Blunt Curved Set of 6 Pcs

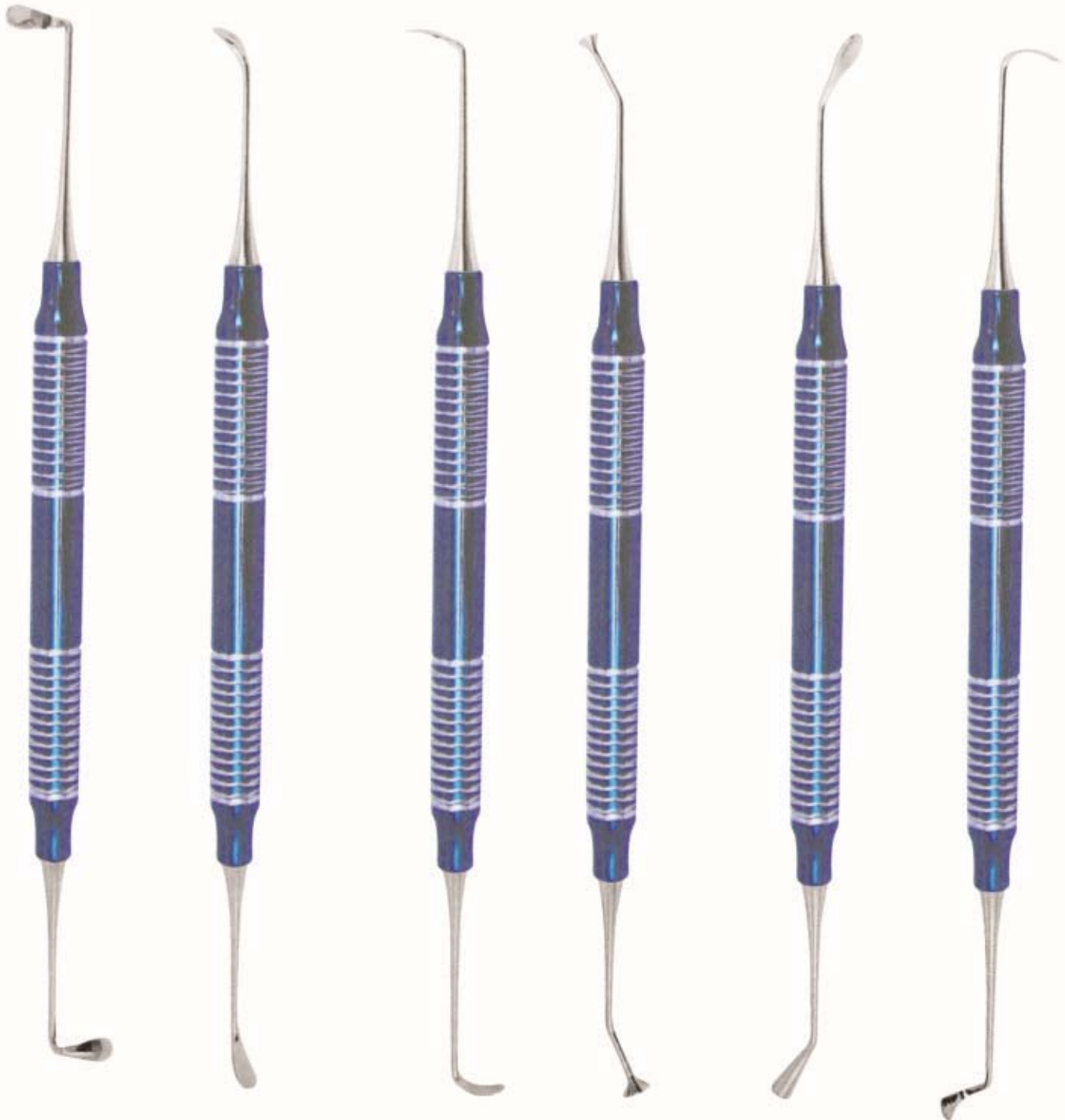

786-1541

786-1542

786-1543

786-1544

786-1545

786-1546



IMPLANTOLOGY

■ Инструменты для имплантологии
■ Implantologie
■ Implantologie

■ Инструменти для імплантології
■ Implantologia
■ زراعة الأسنان

IMPLANT SINUS LIFT INSTRUMENTS PERIODONTAL SURGERY SURGICAL CHISELS KRAMER NEVINS SINUS LIFT



786-1547 TG



786-1548 SOLT 3/4



786-1549 TGO



2786-1550 29K



786-1551 FEDI4



786-1552 OCH3



786-1553 OCH4



786-1554 FEDI1



786-1555 FEDI2



786-1556 FEDI3



786-1557 Gf36

IMPLANTOLOGY

■ Инструменты для имплантологии
 ■ Implantologie
 ■ Implantologie

■ Инструменти для імплантології
 ■ Implantoloia
 ■ زراعة الأسنان

IMPLANT

SURGICAL CHISELS

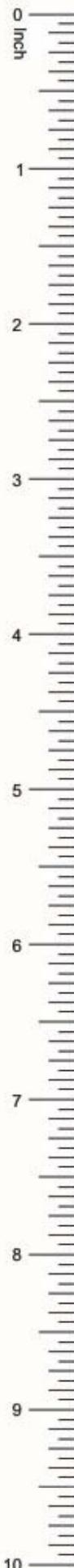
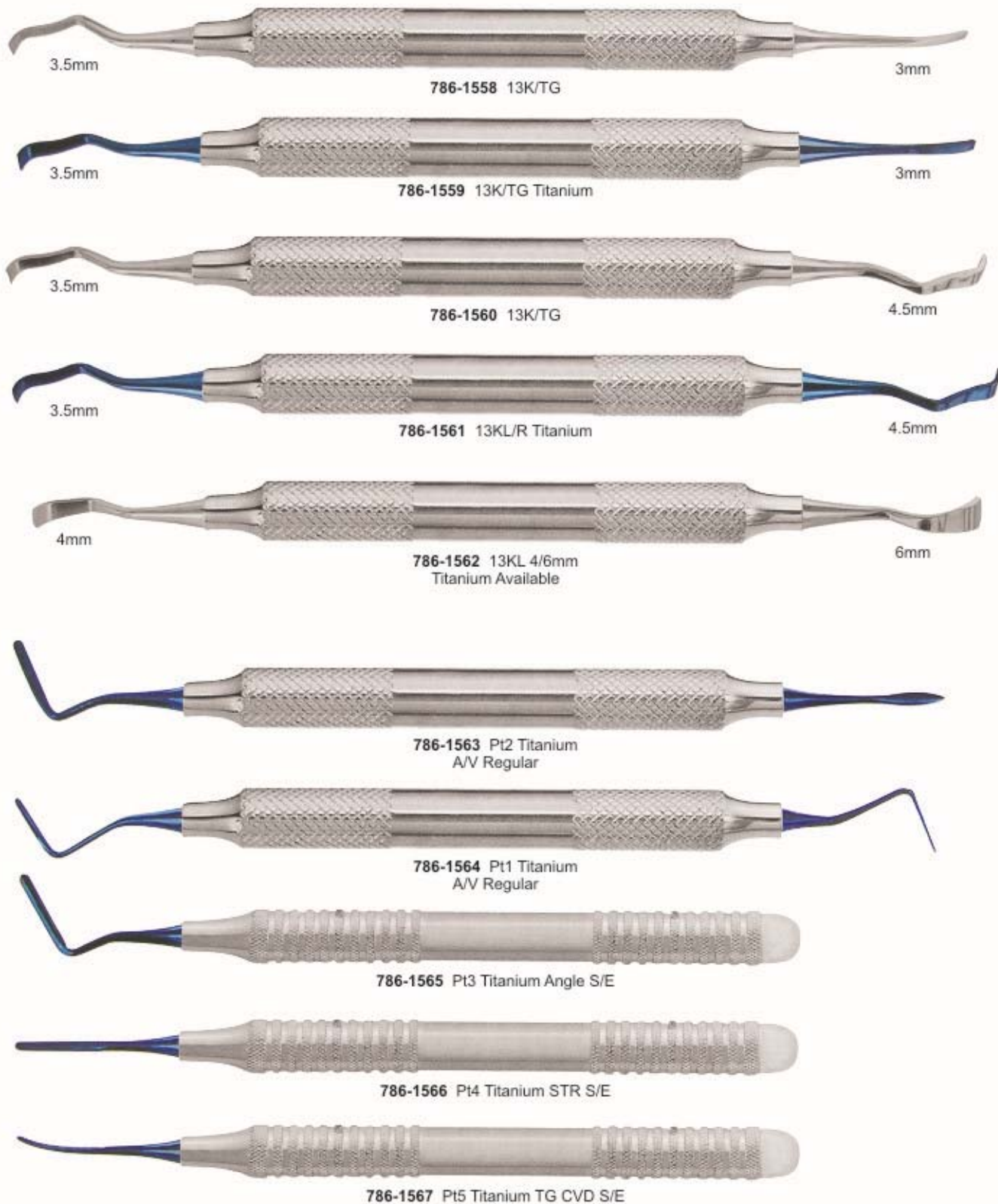

■ Инструменты для имплантологии
 ■ Implantologie
 ■ Implantologie

■ Інструменти для імплантології
 ■ Implantologia
 ■ زراعة الأسنان

MIXING SPATULA WITH SHOVEL



786-1568
 Bone Carrier
 Titanium



786-1569
 Raspator, Prichard
 Length 180 mm
 10 mm hollow handle,
 double-ended
 10.5mm | 4.5mm



786-1570
 Raspator, Prichard
 Length 180 mm
 10 mm hollow handle,
 double-ended



786-1571
 Raspator, Prichard
 Length 180 mm
 10 mm hollow handle,
 double-ended
 10.5mm | 4.5mm



786-1572
 Mixing Spatula
 with shovel
 17cm



786-1573
 Mixing Spatula
 with shovel
 18.5cm

IMPLANTOLOGY

- Инструменты для имплантологии
- Implantologie
- Implantologie

- Инструменти для імплантології
- Implantologia
- زراعة الأسنان

BONE GRAFTING INSTRUMENTS COMPACTOR/TAMPERS

Product offering includes instruments for harvesting, mixing and compacting bone Provides clinicians with the proper instrumentation for bone grafting procedures Weighted bone basin Prevents tipping and spilling of bone and other materials during mixing



786-1574
Graft Packer,
Convave Tips
DE 4/6mm

786-1575
Bone Spoon/
Packer DE 3mm

786-1576
Graft Packer,
Serrated Tips
DE 6/8mm

786-1577
Graft Packer,
Serrated Tips
DE 3/4mm

786-1578
Graft Packer,
Smooth Tip
DE 5/8mm

786-1579
Titanium graft packer
placement site depth
gauge 3.3mm & 4.0mm
Diameter tips Marked
at 8, 11, 13, 16 & 18mm

786-1580
Graft Material
Spoon Concave
Tip For
Larger Grafts



■ Инструменты для имплантологии
 ■ Implantologie
 ■ Implantologie

■ Инструменти для імплантології
 ■ Implantologia
 ■ زراعة الأسنان

BONE GRAFTING INSTRUMENTS



**786-1581
Blade and Pusher**
 Length 180mm,
 for straight or angled
 blade, 15 x 5mm,
 pusher 4mm diameter
 Straight



**786-1582
Blade and Pusher**
 Length 180mm,
 for straight or angled
 blade, 15 x 5mm,
 pusher 4mm diameter
 angular



**786-1583
Spoon and Pusher**
 Length 180mm,
 for angled spoon
 10 x 5mm pusher
 diameter 3mm



**786-1584
Tunnellerungs
Instruments**
 Length 175mm,



**786-1585
Tunnellerungs
Instruments**
 Length 175mm,
 diameter designs



**786-1586
Tamper**
 Length 170mm,
 for bone material
 double ended,
 diameter 3.2 mm
 (2-4-6-8-10) and diameter
 2.5mm (2-4-6-8-10)

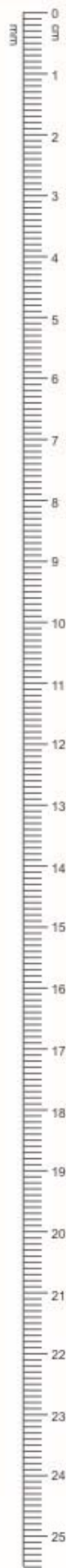

IMPLANTOLOGY

■ Инструменты для имплантологии
 ■ Implantologie
 ■ Implantologie

■ Инструменти для імплантології
 ■ Implantologia
 ■ زراعة الأسنان



Plugers Clarizio

Length 160 mm with titanium tips for mixing and pouring of autologous heterologous bone substitute material (3/4 or 6/8 mm)

BONE GRAFTING INSTRUMENTS



786-1587 Ø4mm
786-1588 Ø5mm
 Compactor
 150mm



786-1589
 Sinus Window
 Bone Tampers
 4 mm



786-1590
 Sinus Window
 Bone Tampers
 7 mm



786-1591
 6/8mm



786-1592
 3/4mm

■ Инструменты для имплантологии
 ■ Implantologie
 ■ Implantologie

■ Инструменти для імплантології
 ■ Implantoloia
 ■ زراعة الأسنان

SPOON AND PUSHER (TRINOVO)

Trinovo handle different workers, for bone material high grade medical stainless steel, corrosion-resistant

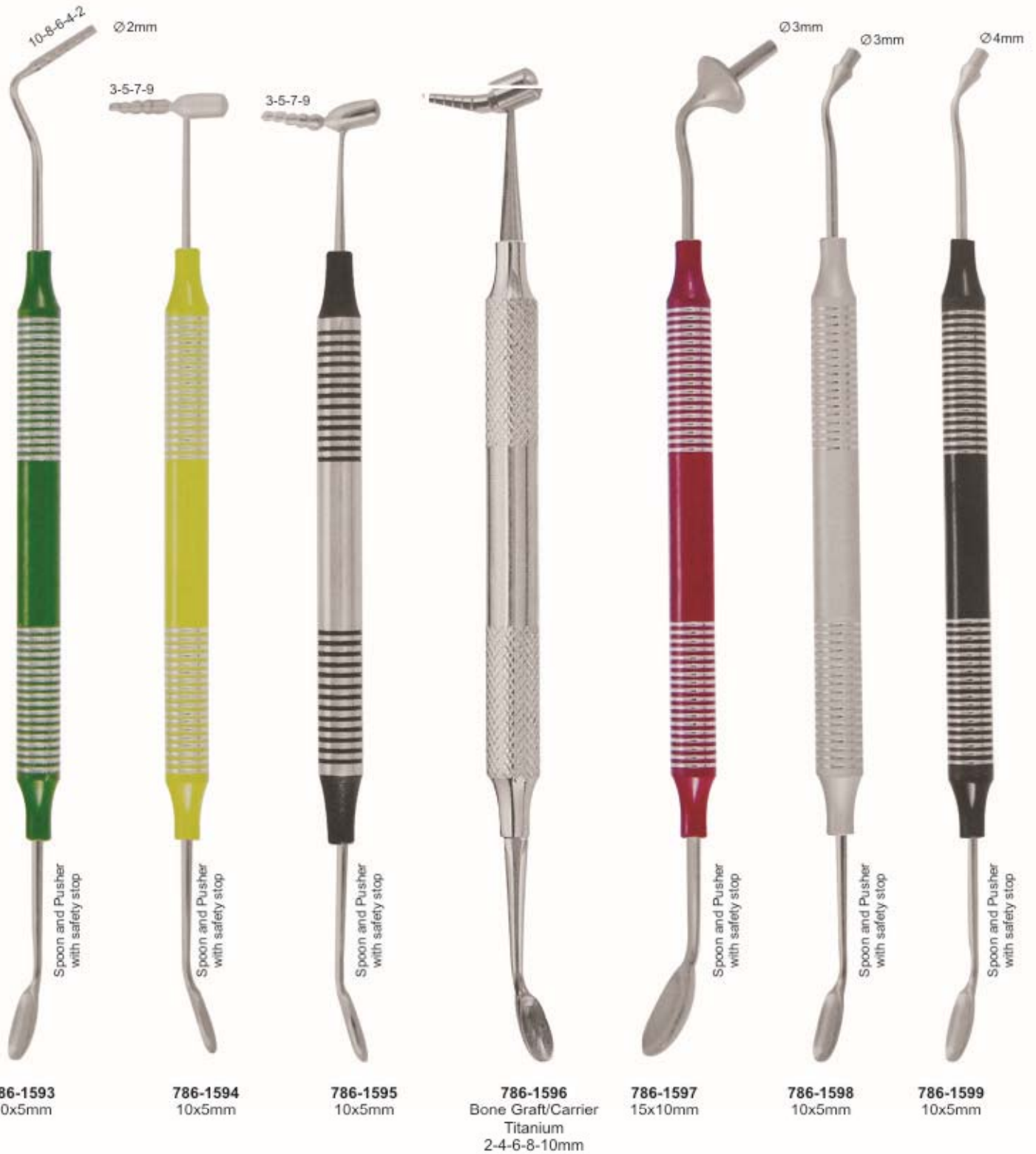

IMPLANTOLOGY

■ Инструменты для имплантологии
 ■ Implantologie
 ■ Implantologie

■ Инструменти для імплантології
 ■ Implantoloia
 ■ زراعة الأسنان

PERIOSTEALS ELEVATOR 10mm Hollow Handle

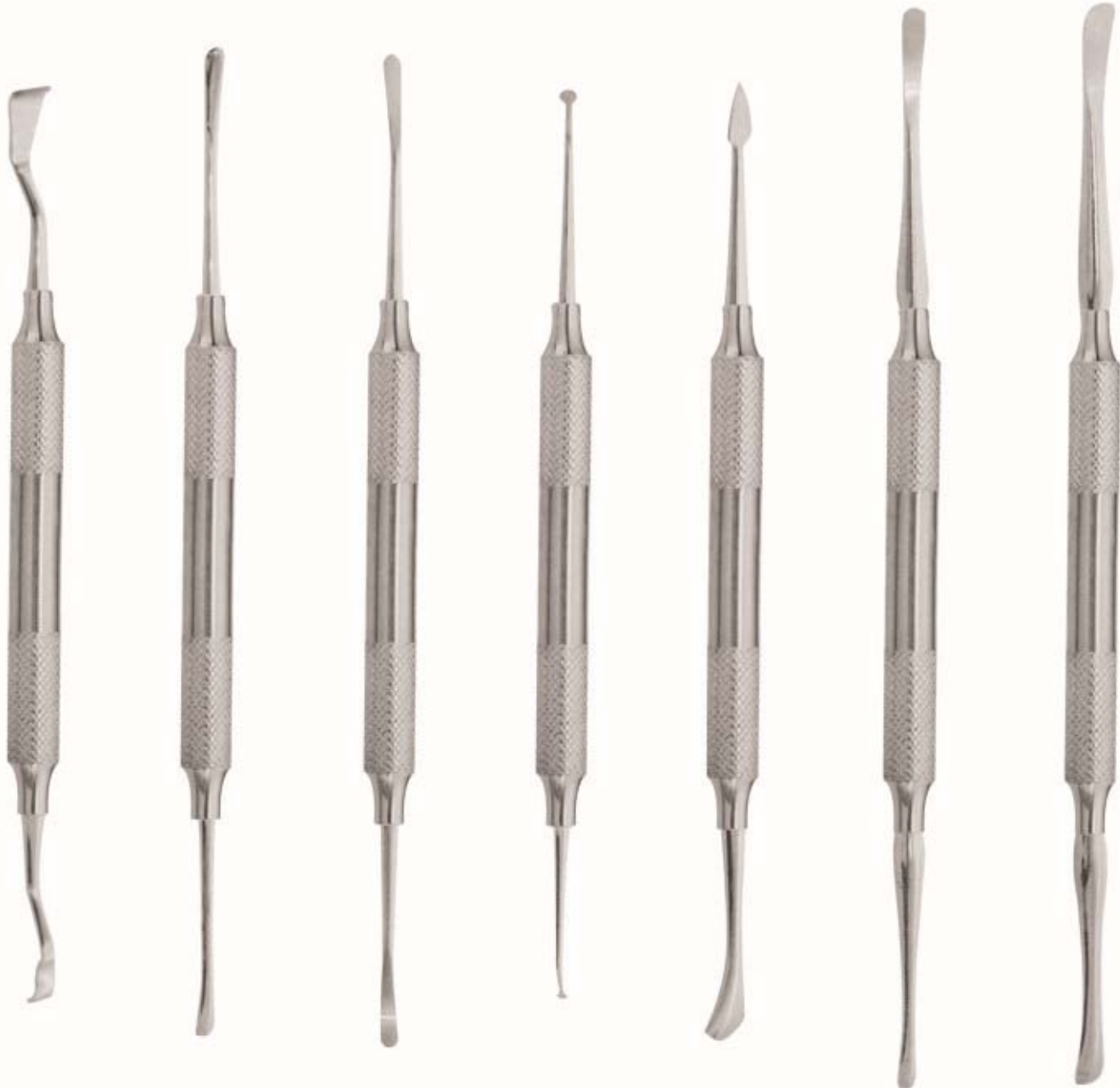

786-1600
Raspator,
BonexScraper
 Length 165 mm
 10 mm hollow
 handle,
 double-ended
 6 mm / 4 mm

786-1601
Raspator,
Raspatory
 Length 180 mm
 10 mm hollow
 handle,
 double-ended
 3 mm / 3 mm

786-1602
Raspator,
Raspatory
 Length 180 mm
 10 mm hollow
 handle,
 double-ended
 3 mm / 3 mm

786-1603
Raspator,
Papilla
 Length 185 mm
 10 mm hollow
 handle,
 double-ended
 3 mm / 2 mm

786-1604
Raspator,
Bone Scraper
 Length 175 mm
 10 mm hollow
 handle,
 double-ended

786-1605
Raspator,
Micro-Freer
 Length 180 mm
 6 mm solid grip
 double-ended
 3 mm / 4 mm

786-1606
Raspator,
Micro-Freer
 Length 180 mm
 6 mm solid
 handle
 double-ended
 5 mm / 5 mm



■ Инструменты для имплантологии
 ■ Implantologie
 ■ Implantologie

■ Инструменти для імплантології
 ■ Implantologia
 ■ زراعة الأسنان

PERIOSTEALS ELEVATOR 10mm Hollow Handle



786-1607
Raspator,
Freer
 10 mm hollow
 handle
 high-quality
 medical
 double-ended



786-1608
Raspator,
Molt
 Length 180 mm
 8 mm solid grip
 double-ended
 6 mm



786-1609
Raspator,
Micro-Freer
 Length 185 mm
 10 mm hollow
 handle
 double-ended



786-1610
Raspator,
Micro-Freer
 Length 185 mm
 10 mm hollow
 handle
 double-ended



786-1611
Raspator,
Micro Raspator/
Chisel
 Length 170 mm
 10 mm hollow
 handle
 double-ended



786-1612
Raspator,
Micro Raspator/
Chisel
 Length 175 mm
 10 mm hollow
 handle
 double-ended



786-1613
Raspator,
Micro Raspator/
Chisel
 Length 175 mm
 8 mm solid
 handle
 double-ended
 3.5mm / 3.5mm

IMPLANTOLOGY

■ Инструменты для имплантологии
 ■ Implantologie
 ■ Implantologie

■ Инструменти для імплантології
 ■ Implantoloia
 ■ راعة الأسنان

PERIOSTEALS ELEVATOR 10mm Hollow Handle



786-1614
Raspatory
Micro Molt
 Length 175 mm
 corrosion-resistant

786-1615
Raspatory Chipping
 Workers:
 Chisel 24G and 7.5mm
 Length about 175 mm
 corrosion-resistant

786-1616
Raspatory Molt
 Work ends.
 5.0 mm and 4.0 mm
 Length about 175 mm
 corrosion-resistant

786-1617
Rasp, Molt M9
 Length 175 mm
 corrosion-resistant

786-1618
Raspator, Wautier
 Length 175 mm
 corrosion-resistant

786-1619
Raspator, Benque
 Length 170 mm
 workers
 5 mm / 7 mm
 corrosion-resistant

786-1620
Raspator, Nordberg
 Length 180 mm
 8 mm hollow handle
 double ended
 6 mm / 4 mm



IMPLANTOLOGY

■ Инструменты для имплантологии
■ Implantologie
■ Implantologie

■ Инструменти для імплантології
■ Implantologia
■ زراعة الأسنان

Hollow Handle 10mm Length 170mm

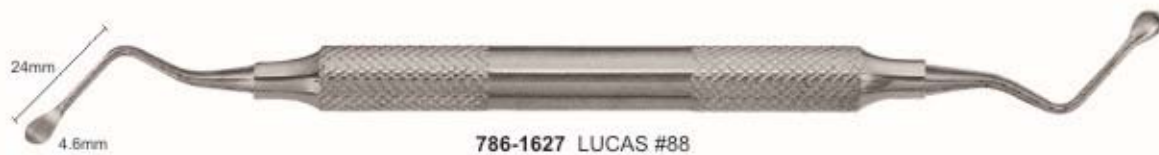

IMPLANTOLOGY

■ Инструменты для имплантологии
 ■ Implantologie
 ■ Implantologie

■ Инструменти для імплантології
 ■ Implantoloia
 ■ زراعة الأسنان

TISSUE MEMBRANE FORCEPS



786-1630
 Tissue Graft Forcep
 Serrated Teeth



786-1631
 Self Locking
 Grooved



786-1632
 Tissue Graft Forcep
 Serrated Teeth



786-1633
 Titanium
 Locking Plier



786-1634
 TC Gripper Carbide
 Tipped Tissue Forceps
 Serrated Carbide Tips
 14.5



786-1635
 Adson Carbide
 Tipped Tissue Forceps
 Serrated Carbide Tips
 12cm



786-1636
 Micro Adson 1x2
 Tissue Forcep 12.1cm
 1x2 Teeth - 0.5mm Tips



786-1637
 Adson 7x7
 Tissue Forceps
 7x7 Teeth 12cm



786-1638
 Adson 7x7 Curved
 Tissue Forceps
 7x7 Teeth 12cm



786-1639
 Suture Pliers
 Suture Forceps with
 1.6mm Ring Tip



786-1640
 Debakey Atraumatic
 Tissue Forceps Straight
 Serrated Teeth
 16cm



786-1641
 Debakey Atraumatic
 Tissue Forceps Curved
 Serrated Teeth
 16cm



■ Инструменты для имплантологии
 ■ Implantologie
 ■ Implantologie

■ Инструменти для імплантології
 ■ Implantologia
 ■ زراعة الأسنان

TISSUE MEMBRANE FORCEPS



786-1642
 Russian Long
 Tissue Forceps
 Serrated Tip
 20cm



786-1643
 Russian
 Tissue Forceps
 Serrated Tip
 15cm



786-1644
 Tissue Punch Forceps
 To Remove Tissue
 After Using Punch



786-1645
 13.5 cm
 narrow



786-1646
 10.5 cm
Membrane Tweezer Kuehne



786-1647
 13.5 cm
 wide



786-1648
Pin Tweezers
 with or without lock
 length 15 cm,
 with lock



786-1649
 without lock



786-1650
Haltepinzette with lock
 15.5 cm, for pins, towards
 the tips, etc,



786-1651
Carry Forceps
 15cm



786-1652
Carry Forceps
 15cm



786-1653
Carry Forceps
 15cm

IMPLANTOLOGY

■ Инструменты для имплантологии
 ■ Implantologie
 ■ Implantologie

■ Инструменти для імплантології
 ■ Implantoloia
 ■ زراعة الأسنان

OSTEOTOME CONVEXES / CONCAVE / CONIQUES

CONVEXES



786-1654
SET OF 5 PIECES

CONCAVE



786-1655
SET OF 5 PIECES

CONIQUES



786-1656
SET OF 5 PIECES



	CONVEXES STRAIGHT	786-1654	2.7 Ømm	3.2 Ømm	3.7 Ømm	4.2 Ømm	5.0 Ømm
	CONVEXES STRAIGHT	786-1655	2.7 Ømm	3.2 Ømm	3.7 Ømm	4.2 Ømm	5.0 Ømm
	CONVEXES STRAIGHT	786-1656	2.7 Ømm	3.2 Ømm	3.7 Ømm	4.2 Ømm	5.0 Ømm

0 Inch

1

2

3

4

5

6

7

8

9

10

■ Инструменты для имплантологии
 ■ Implantologie
 ■ Implantologie

■ Інструменти для імплантології
 ■ Implantologia
 ■ رعاة الأسنان

OSTEOTOME CONVEXES / CONCAVE / CONIQUES

CONVEXES



786-1657
SET OF 5 PIECES

CONCAVE



786-1658
SET OF 5 PIECES

CONIQUES



786-1659
SET OF 5 PIECES



	CONVEXES STRAIGHT	786-1657	2.7 Ømm	3.2 Ømm	3.7 Ømm	4.2 Ømm	5.0 Ømm
	CONVEXES STRAIGHT	786-1658	2.7 Ømm	3.2 Ømm	3.7 Ømm	4.2 Ømm	5.0 Ømm
	CONVEXES STRAIGHT	786-1659	2.7 Ømm	3.2 Ømm	3.7 Ømm	4.2 Ømm	5.0 Ømm

IMPLANTOLOGY

■ Инструменты для имплантологии
 ■ Implantologie
 ■ Implantologie

■ Инструменти для імплантології
 ■ Implantologia
 ■ زراعة الأسنان

TREPINE

Burs with depth markings are suited for precise and simple transplantation of cylindrical bone grafts as well as for all other bone extraction tasks.



786-1660 ∅ Int. 2.0mm ∅ Ext. 3.0mm	786-1661 ∅ Int. 3.0mm ∅ Ext. 3.5mm	786-1662 ∅ Int. 4.0mm ∅ Ext. 5.0mm	786-1663 ∅ Int. 5.0mm ∅ Ext. 6.0mm	786-1664 ∅ Int. 6.0mm ∅ Ext. 7.0mm	786-1665 ∅ Int. 7.0mm ∅ Ext. 8.0mm	786-1666 ∅ Int. 8.0mm ∅ Ext. 9.0mm	786-1667 ∅ Int. 9.0mm ∅ Ext. 10.0mm	786-1668 ∅ Int. 10 mm ∅ Ext. 11mm
---	---	---	---	---	---	---	--	--



786-1669
Tissue Punch with pin
Set of Four Pieces

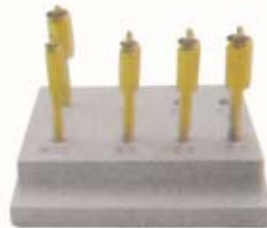

786-1670
Tissue Punch
Set of Five Pieces



786-1671
Tissue Punch with pin
Set of Five Pieces



786-1672
Trephine Drill
Set of Eight Pieces



∅ 2.0mm ∅ 2.5mm ∅ 2.8mm ∅ 3.2mm ∅ 3.65mm ∅ 4.2mm ∅ 5.2mm

786-1673
Short Implant Drills

786-1674
Long Implant Drills



786-1675
Trephine Drill
Set of Eight Pieces



IMPLANTOLOGY

■ Инструменты для имплантологии
 ■ Implantologie
 ■ Implantologie

■ Инструменти для імплантології
 ■ Implantologia
 ■ زراعة الأسنان

BONE SCRAPER STRAIGHT & CURVED



786-1676
Bone Scraper
Straight

786-1677
Bone Scraper
Curved

TISSUE PUNCH STRAIGHT & CURVED



786-1679
2.0mm

786-1680
4.0mm

786-1681
5.0mm

786-1682
6.0mm

786-1683
7.0mm

786-1684
8.0mm

786-1678
Tissue Punch
Straight



786-1686
2.0mm

786-1687
4.0mm

786-1688
5.0mm

786-1689
6.0mm

786-1690
7.0mm

786-1691
8.0mm

786-1685
Tissue Punch
Curved



786-1692
Bone Mill



786-1693
Basins for Bone



786-1694
BONE CRUSHER

IMPLANTOLOGY

■ Инструменты для имплантологии
 ■ Implantologie
 ■ Implantologie

■ Инструменти для імплантології
 ■ Implantologia
 ■ زراعة الأسنان

KEYS FOR IMPLANT SCREW



786-1695



786-1696



786-1697



786-1698

TORQUE WRENCH & RATCHET



786-1699

Star Torque Wrench 6.35mm Universal



786-1705

Star Torque Wrench 6.35mm Universal



786-1711

Star Ratchet Wrench 6.35mm Universal



786-1700

Round Torque Wrench 4.0mm Universal



786-1706

Star Torque Wrench 6.35mm Universal



786-1712

Star Ratchet Wrench 4.0mm Universal



786-1701

Hex Driver with 4.0mm Driver



786-1707

Star Torque Wrench 6.35mm Universal



786-1713

Round Ratchet Wrench 4.0mm Universal



786-1702

Star Torque Wrench 6.35mm Universal



786-1708

Star Torque Wrench 6.35mm Universal



786-1714

Round Ratchet Wrench 3.35mm Universal



786-1703

Hex Torque Wrench 4.0mm Universal



786-1709

Star Ratchet Wrench 6.35mm Universal



786-1715

Star Ratchet Wrench 4.0mm Universal



786-1704

Star Torque Wrench 6.35mm Universal



786-1710

Star Ratchet Wrench 6.35mm Universal



786-1716

Star Ratchet Wrench 6.35mm Universal



IMPLANTOLOGY

- Инструменты для имплантологии
- Implantologie
- Implantologie

- Инструменти для имплантології
- Implantoloia
- زراعة الأسنان

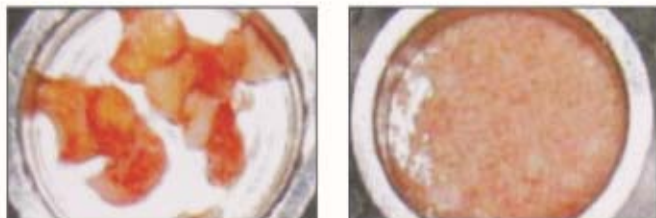

786-1717
BONE CRUSHER
Titanium Metal Cutter

Mallet



786-1718
BONE CRUSHER
Titanium Metal Cutter

Mallet



786-1719
BONE CRUSHER



786-1720
BONE CRUSHER
Bone Grinding Grain
1.5mm, 2mm, 2.5mm



786-1721
BONE CRUSHER
Bone Grinding Grain
1.5mm, 2mm, 2.5mm

IMPLANTOLOGY

■ Инструменты для имплантологии
 ■ Implantologie
 ■ Implantologie

■ Инструменти для імплантології
 ■ Implantoloia
 ■ زراعة الأسنان

BONE EXPANDER SCREW & SURGICAL KITS



786-1722
 Bone Universal Kit
 Drill 2mm, 2.8mm, 3.2mm, 3.65mm
 4.2mm, 4.5mm, 4.8mm, 5.2mm
 Trephines Bit:
 3.0mm, 4.0mm, 5.0mm, 6.0mm
 7.0mm, 8.0mm, 9.0mm, 10.0mm
 Driver:
 2.5mm, 2.5mm Hand Pcs
 1.25mm, 1.25mm Hand Pcs
 Short Driver 2.5mm
 Long Driver 2.5mm
 1.25mm, Short Hex Driver Hand Pcs
 1.25mm, Long Hex Driver Hand Pcs
 Torque Wrench 4.0mm



786-1723
 Bone Expander Kit
 Expander 2.5mm, 3.0mm
 3.4mm, 3.8mm, 4.3mm
 Ratchet Driver:
 Parallel Pin
 Pilot Drill
 Drill 1.4mm
 Drill Driver 4mm
 Hand Driver 4mm
 Ratchet 4.0mm



786-1724
 Bone Universal Kit
 Drill 2mm, 2.8mm, 3.2mm, 3.65mm
 4.2mm, 4.5mm, 4.8mm, 5.2mm
 Trephines Bit:
 3.0mm, 4.0mm, 5.0mm, 6.0mm
 7.0mm, 8.0mm, 9.0mm, 10.0mm

Bone Compression:
 2mm, 3.3mm, 2.8mm, 4.2mm, 3mm, 3.5mm
 Driver:
 2.5mm, 2.5mm Hand Pcs
 1.25mm, 1.25mm Hand Pcs
 Short Driver 2.5mm
 Long Driver 2.5mm
 1.25mm, Short Hex Driver Hand Pcs
 1.25mm, Long Hex Driver Hand Pcs
 Torque Wrench 6.35mm 1 Pcs



786-1725
 Conical Drills: 20 Pcs
 Tissue Punches:
 3.0mm, 3.50mm, 4.0mm, 4.5mm
 5.0mm, 6.0mm, 6.50mm
 Bone Expander:
 1.6/3.8mm, 2.9/3.0mm, 2.1/3.6mm
 2.6/3.8mm, 2.9/4.3mm
 Drill Adapter: 1 Pcs
 1.25mm, 2.50mm, Hex Driver Hand Pcs

Pilot Drill 1.6mm
 Drill Bit: 1.4mm, 1.6mm, 1.8mm,
 2.0mm, 2.2mm
 Ratchet Driver: 4mm/6.35, 1.25/2.50
 Rimer: 3.2/4.7mm, 3.7/4.7mm
 Parallel Pin: 4.5mm, 2.5mm
 Double step Drill: 2.4/2.8mm
 Depth Gauge 1Pcs
 Torque Wrench 6.35mm Universal 1Pcs



■ Инструменты для имплантологии
 ■ Implantologie
 ■ Implantologie

■ Инструменти для імплантології
 ■ Implantologia
 ■ زراعة الأسنان

BONE INJECTORS, COLLECTORS & SUCTION TUBE



786-1726
 Ø2.5mm/
 3.5mm
 170mm

786-1727
 Ø4.5mm/
 5.5mm
 170mm

786-1728
 Ø3.5mm/
 4.5mm
 170mm

786-1729
 Ø6.0mm/
 7.0mm
 170mm

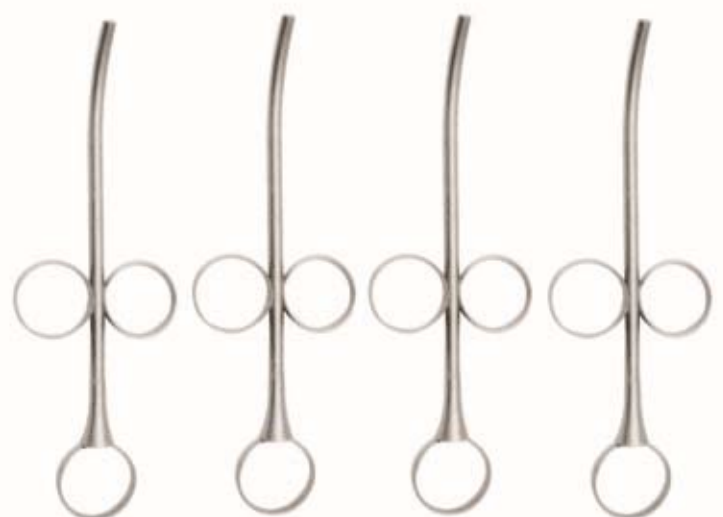

786-1730
 18cm
 Straight / Bend
 I.D 2.5mm
 O.D 3.5

786-1731
 18cm
 Straight / Bend
 I.D 3.5mm
 O.D 4.5

786-1732
 18cm
 Straight / Bend
 I.D 4.5mm
 O.D 5.5

786-1733
 18cm
 Straight / Bend
 I.D 6.0mm
 O.D 7.0



2cm

2.7cm

With Filter

786-1734
 17.5cm

786-1735
 18cm

786-1736
 coarse
 Ø5mm

786-1737
 fine
 Ø9mm

Suction tubes
 to collect
 the extracted
 bone material
 180mm



1.5cm

3cm

5cm

786-1738
 Suction
 Tubes
 180mm

786-1739
 Suction
 Tubes
 180mm

786-1740
 Suction
 Tubes
 180mm



786-1742
 Ø3 mm
 length 180mm
789-1743
 Ø4 mm
 length 180mm
789-1744
 Ø5 mm
 length 180mm

786-1741
 Fig. 6FR
 Frazier
 15 cm - Ø2mm

IMPRESSION TRAYS

- Оттисковые ложки
- Porte-empreinte
- Abdruckloffel

- Відбиткові ложки
- Cubetas para Impresiones
- صواني الانطباع

PERFORATED WITH RIM LOCK

Set of 6 Pcs

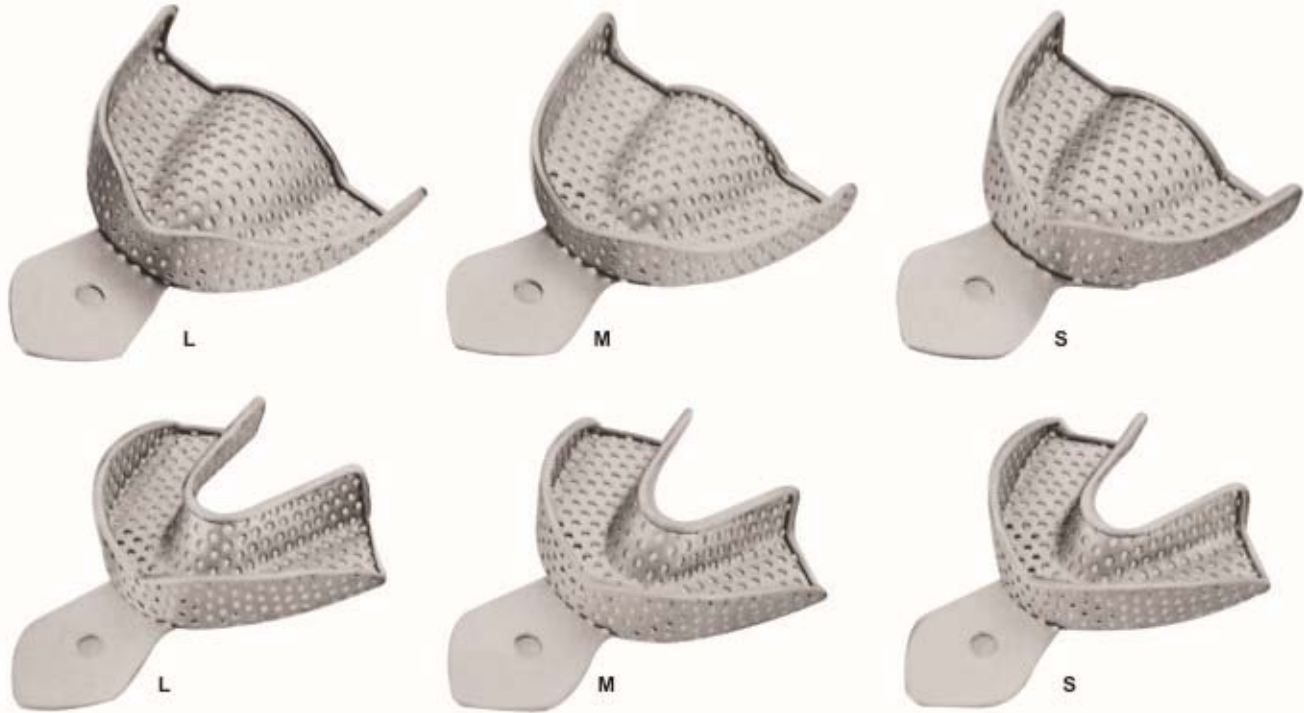

786-1745 SET OF 6 PCS

Upper S, M, L
Lower S, M, L

PERFORATED WITH RIM LOCK

Set of 8 Pcs

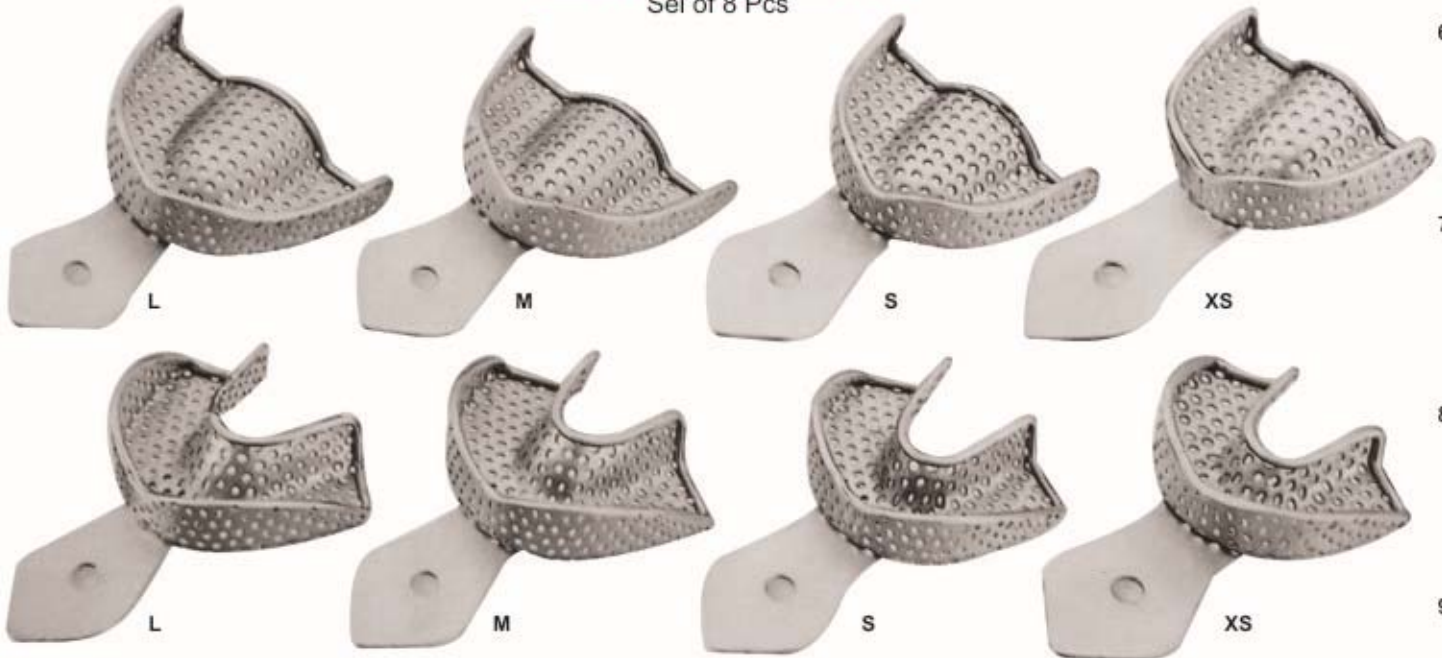

786-1746 SET OF 8 PCS

Upper XS, S, M, L
Lower XS, S, M, L

786-1747 SET OF 8 PCS

Upper S, M, L, XL
Lower S, M, L, XL

786-1748 SET OF 10 PCS

Upper XS, S, M, L, XL
Lower XS, S, M, L, XL



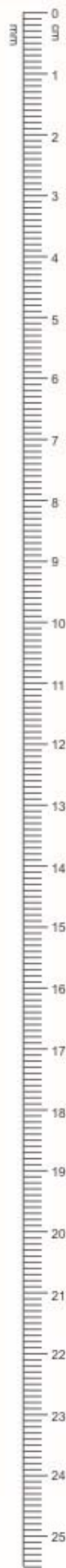

IMPRESSION TRAYS

- Оттисные ложки
- Porte-empreinte
- Abdruckloffel

- Відбиткові ложки
- Cubetas para Impresiones
- صواني الانطباع

SOLID WITH RIM LOCK

Set of 6 Pcs



L



M



S



L



M



S

786-1749 SET OF 6 PCS

Upper S, M, L
Lower S, M, L

SOLID WITH RIM LOCK

Set of 8 Pcs



L



M



S



XS



L



M



S



XS

786-1750 SET OF 86 PCS

Upper XS, S, M, L
Lower XS, S, M, L

786-1751 SET OF 8 PCS

Upper S, M, L, XL
Lower S, M, L, XL

786-1752 SET OF 8 PCS

Upper XS, S, M, L, XL
Lower XS, S, M, L, XL

IMPRESSION TRAYS

- Оттисные ложки
- Porte-empreinte
- Abdruckloffel

- Відбиткові ложки
- Cubetas para Impresiones
- صواني الانطباع

PERFORATED FULL DENTURE

Set of 8 Pcs

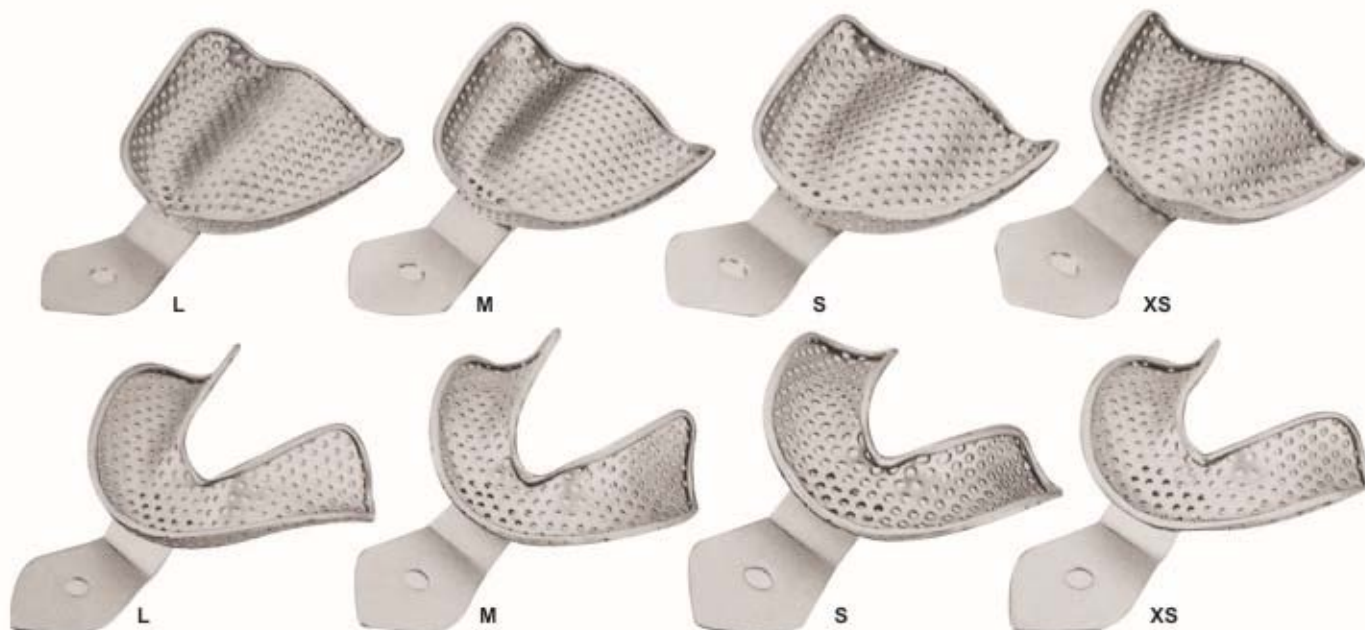

786-1753 SET OF 8 PCS

Upper S, M, L, XL
Lower S, M, L, XL

786-1754 SET OF 8 PCS

Upper S, M, L
Lower S, M, L

SOLID FULL DENTURE

Set of 8 Pcs

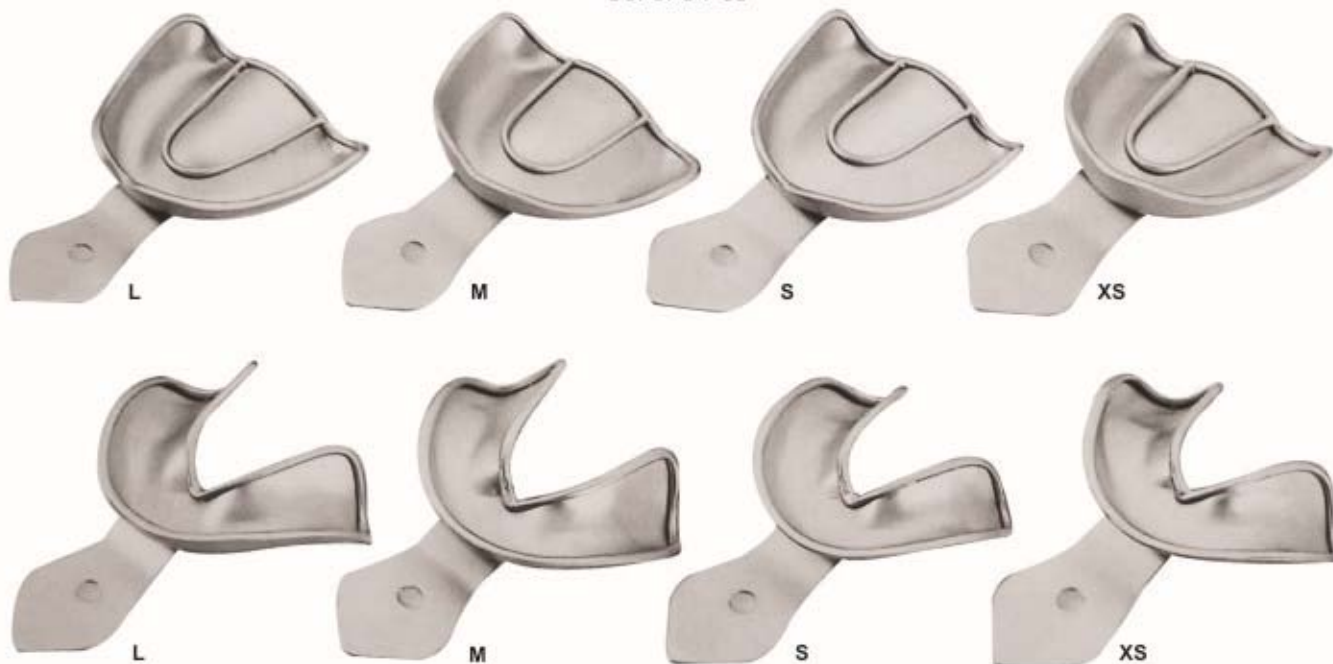

786-1755 SET OF 8 PCS

Upper S, M, L, XL
Lower S, M, L, XL

786-1756 SET OF 6 PCS

Upper S, M, L
Lower S, M, L

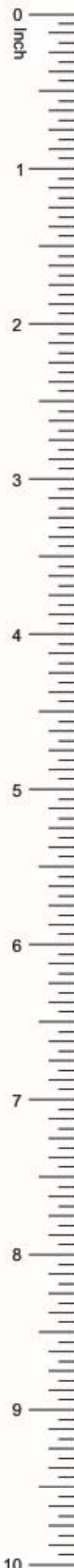

IMPRESSION TRAYS

■ Оттисковые ложки
■ Porte-empreinte
■ Abdruckloeffel

■ Відбиткові ложки
■ Cubetas para Impresiones
■ صواني الاطباق

PERFORATED WITHOUT RIM LOCK

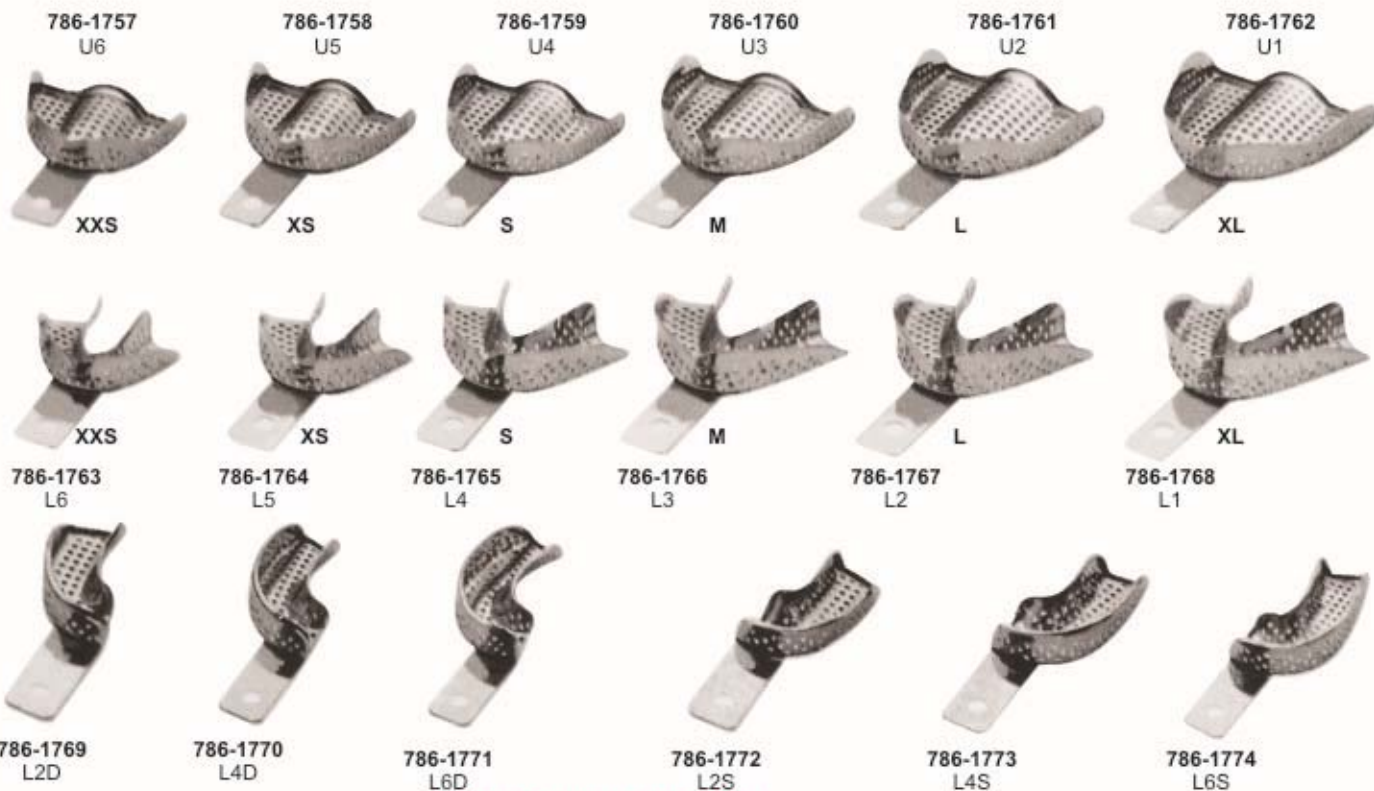

SOLID WITH RIM LOCK

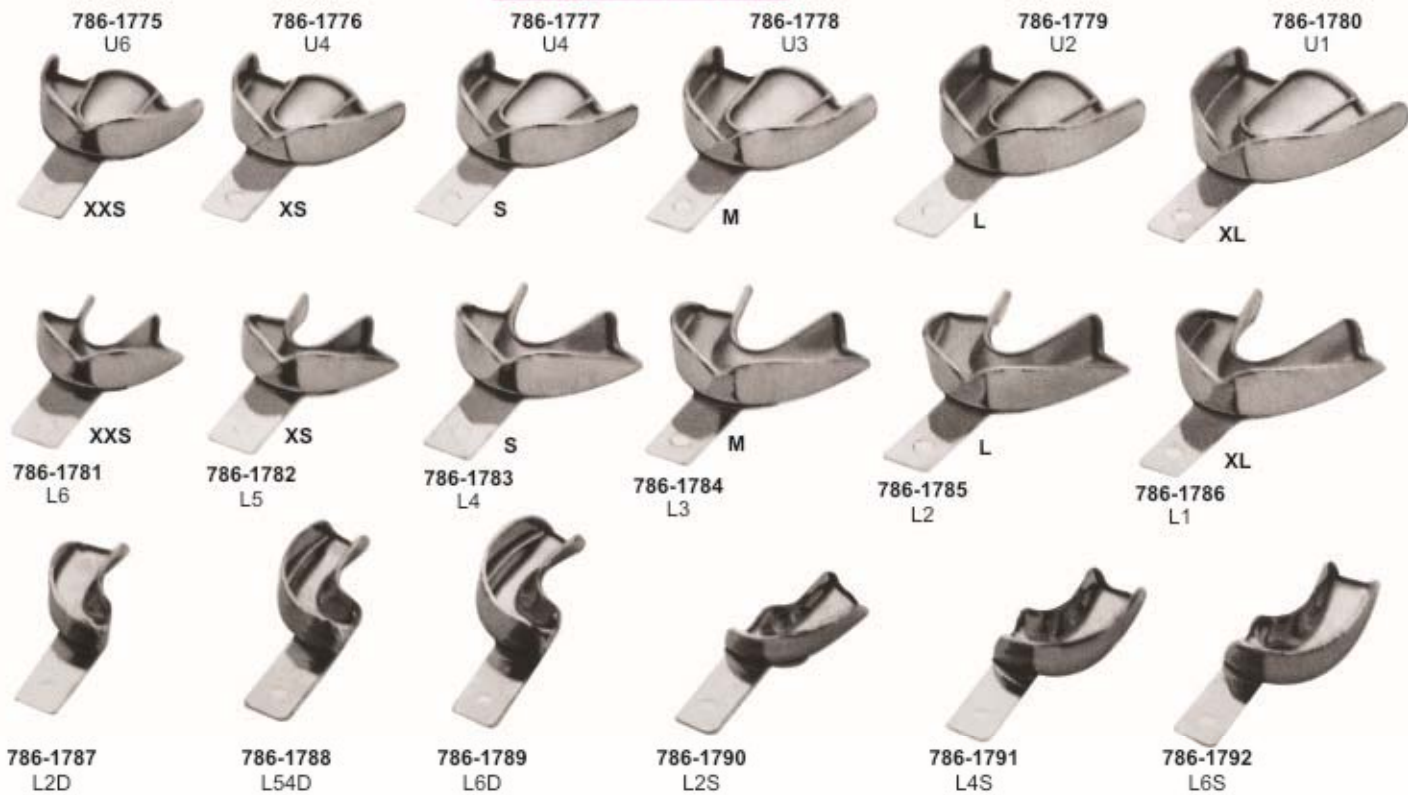

INSTRUMENTS CASSETTES & STANDS



786-1793
Instruments Cassettes
5 Pieces, 7 Pieces, 10 Pieces & 20 Pieces



786-1794
Instruments Cassettes
5 Pieces, 7 Pieces, 10 Pieces & 20 Pieces



786-1795
Instruments Cassettes
7 Pieces & 100 Pieces



786-1796
Gracey Curette Set Cassettes



786-1797
182 x 150 x 20 mm
10 Instruments



786-1798
182 x 85 x 15 mm
5 Instruments



786-1799
288 x 182 x 35 mm
20 Instruments

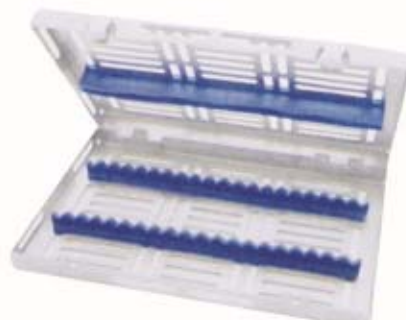

786-1800
288 x 182 x 35 mm
20 Instruments



786-1801
288 x 145 x 35 mm
10 Instruments

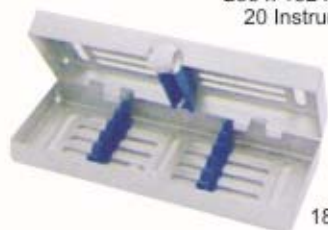

786-1802
1828 x 72 x 35 mm
5 Instruments



786-1804
Gracey Curette Set Stand

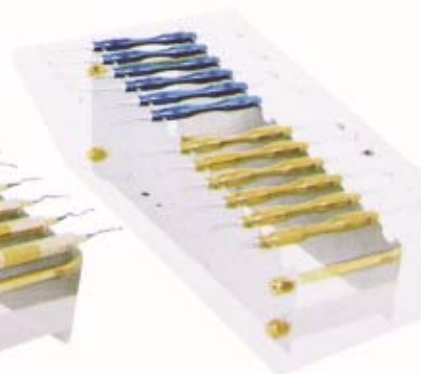

786-1805
Sinus Lift Set Stand



786-1803
182 x 145 x 35 mm
9 Instruments

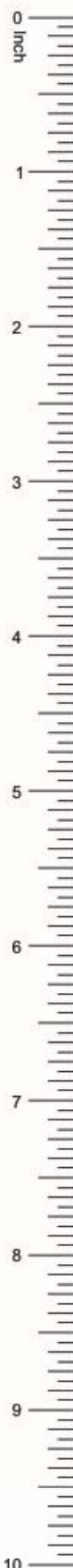

HOLLWO WARE

MADE OF 18/8 STAINLESS STEEL



KIDNEY TRAY WITH COVER
(English Pattern)

	Size
786-1806	150 mm
786-1807	200 mm
786-1808	240 mm
786-1809	300 mm



KIDNEY TRAY

	With lid available		Without lid available
786-1810	6"	786-1814	6"
786-1811	8"	786-1815	8"
786-1812	10"	786-1816	10"
786-1813	12"	786-1817	12"



	Deep
786-1818	2.25" - 2"
786-1819	4.75" - 2"
786-1820	5.5" - 2.5"
786-1821	6.25" - 2.75"
786-1822	7" - 3.5"



Sterilizing Drum

Art #	mm	h mm
786-1823	80 mm	80
786-1824	120 mm	120
786-1825	160 mm	120
786-1826	190 mm	140
786-1827	190 mm	200
786-1828	240 mm	120
786-1829	240 mm	160
786-1830	240 mm	240
786-1831	290 mm	120
786-1832	290 mm	160
786-1833	290 mm	240
786-1834	340 mm	160
786-1835	340 mm	240
786-1836	390 mm	145
786-1837	390 mm	200
786-1838	390 mm	290



Cotton Holder
786-1839



Sprint Lamp
786-1840



786-1841
Endodontic Box



	Forcep Jar
786-1842	25 x 80 mm
786-1843	30 x 100 mm
786-1844	100 x 200 mm
786-1845	75 x 173 mm



786-1846 6" x 8"
786-1847 8" x 10"
786-1848 10" x 12"
Without Lid



786-1849
Instrument Box

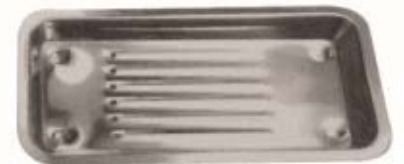

SCALER TRAY
786-1850
100 x 200 mm

INDEX

0
Inch

DESCRIPTION	PAGE #	DESCRIPTION	PAGE #	DESCRIPTION	PAGE #
3 PRONG CLASP ADJUSTABLE PLIER TC	107	CARVERS FILLING INSTRUMENTS	69	FLAT NOSE PLIER WITH SERRATION	105
ACORN FILLING INSTRUMENTS	52	CARVERS INSTRUMENTS	73	FLOHR ROOT ELEVATORS	20
ADAMS PIER WITH TC	102	CARVERS	71	FLUCH-OUT DISTAL AND CUTTING PLIERS	100
ADAMS PLIER ROUND BOX	100	CASTROVIEJO NEEDLE HOLDERS	86	FOERSTER DRESSING FORCEPS	
ADAMS PLIER FOR BENDING WIRE	100	CASTROVIEJO SCISSORS	84	FORCEP JAR	148
ADAMS, SMALL WIRE BENDING AND LOOP FORMING PLIERS	99	CEMENT SPATULAS	75	FREEDMAN "DUCKHEAD" IMPLANTOLOGY INSTRUMENTS	112
ADERER FACEBOW LOOP FORMING PLIERS	101	CHEEK RETRACTORS LONG	80	FREEDMAN "BURNISHERS" IMPLANTOLOGY INSTRUMENTS	112
ADERER LARGE WIRE BENDING AND LOOP FORMING PLIERS	100	CHEEK RETRACTORS	78	FREER PERIOSTEEL ELEVATORS	95
ADERER PLIER	101	CHEEK RETRACTORS MINNESOTA	80	FRIEDMAN BONE RONGEUR	14
ADSON BROWN TWEEZERS	32	CHEEK RETRACTORS, RETRACTOR IVORY	80	FRIEDMAN ROOTS ELEVATORS	21
ADSON CARBIDE TIPPED TISSUE FORCEPS	133	CHEEK RETRACTORS TONGUE DEPRESSORS	80	GUAGE FOR MEASURING	109
ADSON NEEDLE HOLDER	86	CHESEL HOES FILLING INSTRUMENTS	74	GERALD TWEEZERS	31
ADSON TWEEZER	32	CLAMP OSTEO METER	109	GILLES TWEEZERS	31
ADSON TC TWEEZERS	32	CLAMP PIPSON/FRAHAM RESTORATIVE INSTRUMENTS	70	GILLES NEEDLE HOLDER AND SCISSORS	
ALLEN PERIOSTEEL ELEVATORS	95	CLAW-LIFT ROOTS ELEVATOR	22	GOLDMAN FOX EXPLORERS	36
ALLIS 4.5 HAEMOSTATIC FORCEPS	87	COHEN UNIVERSAL FORCEPS	10-10	GOLDMAN FOX MERRILL B EXPLORERS	36
ALLIS-BABY 3.4 HAEMOSTATIC FORCEPS	87	COLLEGE CURVED	32	GOLDMAN FOX UNIVERSITY OF MICHIGAN EXPLORERS	36
AMALGAM CARVERS	56, 57, 70-71	COLLEGE TWEEZER	32	GOLDMAN FOX WILLIAMS EXPLORERS	36
AMALGAM FILES	71	COLLEGE WITH LOCK TWEEZERS	31	GOLDMAN FOX PERIODONTAL INSTRUMENTS	58
AMALGAM INSTRUMENTS & SCALPEL HANDLES	92	COLLINS TONGUE FORCEPS		GOLDMAN FOX PERIOSTEEL ELEVATORS	95
AMALGAM INSTRUMENTS	93	COMPOSITE PLASTIC FILLING INSTRUMENTS	49-50, 54	GOLDMAN FOX SCISSORS	83-84
AMALGAM WELL MATRIX RETAINERS	91	CONDENSER INSTRUMENTS	118	GOLDMAN FOX SET	61
AMALGAM WELL	93	CONDENSER MORTONSON FILLING INSTRUMENTS	50	GOLDSTIEB INTERPROXIMAL ELEVATOR	67
ANATOMICAL CARVER	71	CONTOURING INSTRUMENT / IMPLANTOLOGY INSTRUMENTS	111	GRACEY AFTER FIVE	42
ANDREW RESTORATIVE INSTRUMENTS	70	CONTOURING PLIER	101	GRACEY CURETTE INSTRUMENTS	62
ANGLE FORMERS	72	COSMETIC CONTOURING	113	GRACEY CURETTE SET CASSETTES	147
ANGLED DIRECT BOND BRACKET REMOVER TC	106	COTTON HOLDER	148	GRACEY CURETTE	43
ANISWORTH CLAMPS FORCEPS	88	COUPLAND ROOT ELEVATOR	17	GRACEY MINI FIVE	42
ANTERIOR FILLING INSTRUMENTS	68	COUPLAND ROOT ELEVATOR	18	GRACEY PERIODONTAL INSTRUMENTS	39
ANTERIOR	47	CRANE KAPLAN TWEEZER	32	GRACEY CURETTE SET OF 7 Pcs	40-41
APEXO ROOT ELEVATORS	15-19	CRANE KAPLAN PERIODONTAL INSTRUMENTS	59	GRAFT PACKER, CANCAVE TIPS	125
APICAL ROOT ELEVATORS	19	CRILE NEEDLE HOLDERS	85	GREGG IMPLANTOLOGY INSTRUMENTS	111
ARCH FORMING PLIERS	104	CRILE WOOD NEEDLE HOLDERS	85-86	GRITMAN CEMENT SPATULAS	75
ARTICULATORS	77	CROWN AND BAND CONTOURING PLIERS	105	GROSS MAIER DRESSING FORCEPS	
A-TRAUMATIC EXTRACTION SET	03	CROWN REMOVER	90	GUM SCISSORS	
ATRAUMATIC TWEEZER	31	CROWN SPREADERS	90	HAEMOSTATIC FORCEPS & TOWEL CLAMPS	87
BACK ACTION FILLING INSTRUMENTS	52	CRUYER EXTRACTING FORCEPS		HALSEY NEEDLE HOLDERS	85-86
BACKHAUS HAEMOSTATIC FORCEPS	87	CRUYER ROOTS ELEVATORS	23	HALSTEAD MOSQUITO HAEMOSTATIC FORCEPS	87
BACOLITE HANDLE VIAS KNIVES	76	CURETTE COLUMBIA	43	HANSTEAD MOSQUITO NEEDLE HOLDER	86
BALDWIN FILLING INSTRUMENTS	49	CURETTE INSTRUMENTS	63	HALTPINZETTE WITH LOCK	134
BALL FILLING INSTRUMENTS	52	CURETTE McCALL	43	HAMMER HEAD TIE BACK PLIER	104
BALL HOOK CRIMPING PLIER	105	CURETTE	60	HANDLESS MOUTH MIRRORS	30
BAND PUSHER	90	CURETTE SET OF 8 PIECES	43	HARD WIRE CUTTERS	107
BAND REMOVING PLIER	99	CURETTES	40-43, 61-62	HARRIS EXTRACTING FORCEPS	
BAND SEATER AUTO CLEAVABLE	97	CUTTING INS PERIODONTAL INSTRUMENTS	39	HARTMANN (BABY MOSQUITO NEEDLE HOLDER)	86
BAND SEATING PLIER	104	DARBY-PARRY EXCAVATORS	65	HATCHETS FILLING INSTRUMENTS	68
BANDS & CROWN PLIER	101	DE LA ROSA PLIERS WITH GROOVED	105	HEAT CARRIERS	46
BASINS FOR BONE	138	DE LA ROSA PLIERS	105	HEBER ROOTS ELEVATOR	24
BAUMGARTNER NEEDLE HOLDERS	85	DEAN SCISSORS	84	HEIDBRINK ROOTS ELEVATOR	20-21, 26
BAUMGARTNER NEEDLE HOLDERS	86	DEBAKEY ATRAUMATIC TISSUE FORCEPS	133	HEIDMANN PERIODONTAL INSTRUMENTS	39
BAYONET ROOT ELEVATOR SET	21	DEEP BOWL	148	HEMINGWAY CURETTE INSTRUMENTS	63
BEAVERTAL FILLING INSTRUMENTS	52	DEEP ROOT PICK FORCEPS (APICAL SET OF 9)	04	HEMINGWAY TWEEZERS	32
BEEBEE NEEDLE HOLDERS	85	DELICATE NEEDLE HOLDERS	85	HOES	71
BEIN ROOT ELEVATORS	15-16, 24	DELUX BRACKET HOLDER TWEEZERS	96	HOLLANBACK PERIODONTAL INSTRUMENTS	39
BEYER BONE RONGEUR	14	DENHARD CHEEK RETRACTORS	79	HOLLENBACK FILLING INSTRUMENTS	50
BINANGLE FILLING INSTRUMENTS	74	DENTAL MIRRORS PERIODONTAL INSTRUMENTS	39	HOLLENBACK IMPLANTOLOGY INSTRUMENTS	114
BIRD BEAK ANGLED BENDING PLIER	103	DENTAL SYRINGES	14C	HOLLENBACK RESTORATIVE INSTRUMENTS	70
BIRD BEAK PLIER WITH TC	102	DERF NEEDLE HOLDERS	85	HOLLOW HANDLE	132
BIRD BEAK WIRE BENDING & CUTTING PLIERS	101	DERF NEEDLE HOLDERS	86	HOLLOWWARE	148
BIRD BEAK WIRE BENDING PLIERS	100	DIRECT BOND BRACKET HOLDERS TWEEZER	96	HOLLOWCHOP CONTOURING PLIER	106
BIRE BEAK WITH CUTTER PLIERS	104	DIRECT BONDING BRACKET HOLDERS	96	HOOK CRIMPING PLIER ANGLED STRAIGHT TC	107
BLACK FILLING INSTRUMENTS	50	DIRECT BONDING BRACKET REMOVER PLIERS TC	106	HOOK KNIVES	76
BLACK TITANIUM COLOUR COATED INSTRUMENTS	110, 111	DIRECT BRACKET REMOVERS TC	107	HOW PLIER CURVED WITH TC	103
BLADE AND PUSHER	126	DISCOID-CLEOED CARVER	71	HOW PLIER CURVED	99, 104
BLLMENTAL BONE RONGEUR	14	DISTAL END CUTTER REGULAR WITH TC	102	HOW PLIER STRAIGHT WITH TC	103
BOGHOSIAN FILLING INSTRUMENTS	49	DISTAL END CUTTER SAFETY HOLD PLIER		HOW PLIER STRAIGHT	103
BOGHOSIAN IMPLANTOLOGY INSTRUMENTS	111	IDEAL FOR CUTTING WIRE JTC	107	HOWARD PERIOSTEEL ELEVATOR	95
BOLEY GAUGE	109	DISTAL END WIRE CUTTER & BRACKET REMOVER PLIERS	107	HYGIENIST PERIODONTAL INSTRUMENTS	58
BONE BRACKET GAUGE	96	DOUBLE ENDED CEMENT SPATULA	98	HYGIENIST-JACQUETTE PERIODONTAL INSTRUMENTS	58
BONE CARRIERS TITANIUM	124	DRESSING TWEEZER	31-32	HYGIENIST TOWNER PERIODONTAL INSTRUMENTS	58
BONE CRUSHER	138, 140	ELASTIC SEPARATING PLIER	107	HYLIN CEMENT SPATULAS	75
BONE EXPENDER SCREW & SURGICAL SET	141	ELASTOMERIC LIGATURE PLACING FORCEPS		HYLIN ROOTS ELEVATOR	23
BONE FILES	94	WITH GROOVE FALCON	107	IMPLANT GAGES	108
BONE GRAFT/CARRIER TITANIUM	128	ELLIOT MATRIX RETAINERS	91	IMPLANT SINUS LIFT INSTRUMENTS	117, 122
BONE GRAFTING INSTRUMENTS COMPACTOR/TAMPERS	125	ENDED CHEEK RETRACTORS	79	IMPLANT	123
BONE GRAFTING INSTRUMENTS	126-127	ENDODONTIC BOX	148	IMPLANTOLOGY INSTRUMENTS	112
BONE INJECTORS, COLLECTOR & SUCTION TUBE	142	ENDODONTICS INSTRUMENTS	47	IMPLANTOLOGY INSTRUMENTS	111
BONE MILL	138	ENGLISH PATTERN KLEIN #3 PERIODONTAL FORCEPS	08	IMPLANTOLOGY	108-110
BONE RONGEUR	15A	EXAMINATION KIT SET OF 3 PIECES	34	IMPRESSION TRAYS	143-146
BONE SCRAPER STRAIGHT & CURVED	138	EXAMINATION KIT SET OF 4 PIECES	34	INSTRUMENTS BOX	148
BONE SPOONPACKER	125	EXCAVATORS	37	INSTRUMENT CASSETTES & STAND	147
BONE THICKNESS GAUGE	109	EXCAVATORS PERIODONTAL INSTRUMENTS	39	INTERPROXIMAL CARVER IMPLANTOLOGY INSTRUMENTS	111
BONE UNIVERSAL KIT	141	EXCAVATORS INSTRUMENTS SET OF 11 PIECES	57	INTERPROXIMAL OFF-ANGLED FILLING INSTRUMENTS	49
BRACKET REMOVER ANGULATED PLIER	103	EXCAVATORS INSTRUMENTS	64-67	INTRALINGUAL ANESTHESIA SYRINGES	13
BRACKET REMOVER PLIER STRAIGHT	103	EXCAVATORS	64	IRIS SCISSORS	83-84
BRACKET REMOVER PLIER ANGLED WITH TC	102	EXPLORERS PERIODONTAL INSTRUMENTS	39	IVORY LIGHT WEIGHT CLAMPS FORCEPS	88
BRACKET REMOVER PLIER STRAIGHT WITH TC	102	EXPLORERS INSTRUMENTS	35	IVORY MATRIX RETAINER	91
BRACKET REMOVING PLIER ROUND BOX	99	EXPLORERS	33-45	IRVANSON SPRING CALIPER	109
BRACKET REMOVING PLIER	96	EXTRACTING FORCEPS (AMERICAN PATTERN)	10-14, 14A-14B	JACQUETTE SCALER PERIODONTAL INSTRUMENTS	59
BREWER CLAMPS FORCEPS	88	EXTRACTING FORCEPS (ENGLISH PATTERN)	01-02, 05-07	JARA BEAK PLIER	104
BURNISHER FILLING INSTRUMENTS	49	EXTRA-FLEX IMPLANTOLOGY INSTRUMENTS	114	JENNINGS CHEEK RETRACTORS	79
BURNISHER FILLING INSTRUMENTS	54	FALCON BEAK CONTOURING PLIERS	100	JOHANSON CONTOURING PLIERS	100
BURNISHER UNIVERSITY MICHIGAN AMALGAM CARVERS	56	FARABEUF RETRACTOR	82	JONES HAEMOSTATIC FORCEPS	87
BURNISHER FILLING INSTRUMENTS	52-53	FELDMAN RETRACTOR	82	JOSEPH SCISSORS	84
BURNISHER IMPLANTOLOGY INSTRUMENTS	112	FILES FILLING INSTRUMENTS	53	KELLY HAEMOSTATIC FORCEPS	87
BUSER PERIOSTEEL ELEVATORS	95	FILLING INS PERIODONTAL INSTRUMENTS	39	KELLY SCISSORS	83-84
CARRY FORCEPS	134	FILLING INSTRUMENTS	37, 44, 49-55, 69, 72	KELLY-RANKIN HAEMOSTATIC FORCE PIS	87
CARVER HOLLENBACK AMALGAM CARVERS	56	FLATE NOSE PLIER SMOOTH	105	KEFFOR IMPLANT SCREW	139

10

 **WITTEX**
PAKISTAN

 P.O.Box # 635, Wazirabad Road,
Harar, Sialkot 51310 Pakistan.
Tel : + 92-52-3574262-63
Direct : + 92-52- 3574265
Fax : + 92-52-3574266
E-mail : wittex@skt.comsats.net.pk
Web : www.wittex.com

 **WITTEX**
GERMANY

Adolf-Kolping Str # 33
84359 Simbach - Inn
Deutschland (Germany)
Tel : + 49 - 8571- 9251899
Fax : + 49 - 8571- 9251898
E-mail : wittex@t-online.de
www.wittex.de

 **WITTEX**
USA INC

427 s main st suit 311
CEDAR CITY , UT 84720
USA
Ph: 4089960205
wittex.usa@gmail.com
www.wittex.com

 **WITTEX**
CANADA INC

60 Castlemore L6P 3V7
Brampton, ON
Canada
wittex.canada@gmail.com
www.wittex.com